

2021

BROCHURE
BROSCHÜRE

YENİ ÜRÜNLER
NEW PRODUCT
NEUE PRODUKTE

*konusulan
the spoken kalite...
quality...
qualität über die
man spricht...*



www.akko.com.tr

 **AKKO**®

Kesici Uç ve Bağlama Sistemleri
Cutting Inserts and Connection Systems
Trägerwerkzeuge für Wendschneidplatten

POLY-V

POLY-V KANAL AÇMA UÇLARI ve TAKIMLARI
POLY-V GROOVING INSERTS and TOOLHOLDERS
POLY-V EINSTECHPLATTEN UND WERKZEUGE



new

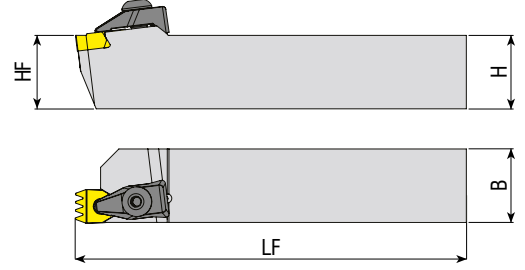

Takım Kodu Ordering Code Bestell-Bezeichnung	Stok Stock Lager		Takım Ölçüleri (mm) Dimension (mm) Abmessung (mm)			Kesici Uç Insert Wendeschneidplatte	Baskı Pabucu Wedge Clamp Spannpratze	Pabuç Vidası Clamp Screw Klemmschraube	Anahtar Allen Key Innensechskantschlüssel
	R	L	HF=H	B	LF				
ATPVK 2020 K2.34X4	○	○	20	20	125	B26.07.0234PJ.x4	ATK-04	AKV-19-M7X25	AAL-05-4
ATPVK 2525 M2.34X4	○	○	25	25	150				
ATPVK 3232 P2.34X4	●	○	32	32	170				
ATPVK 2020 K3.56X4	○	○	20	20	125	B26.07.0356PK.x4	ATK-04	AKV-19-M7X25	AAL-05-4
ATPVK 2525 M3.56X4	○	○	25	25	150				
ATPVK 3232 P3.56X4	●	○	32	32	170				
ATPVK 2020 K4.7X3	○	○	20	20	125	B26.07.0470PL.x3	ATK-04	AKV-19-M7X25	AAL-05-4
ATPVK 2525 M4.7X3	○	○	25	25	150				
ATPVK 3232 P4.7X3	●	○	32	32	170				

new

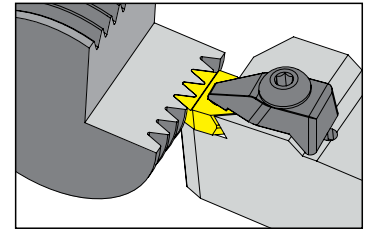
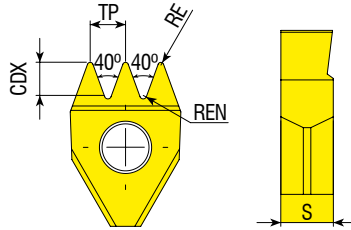

Uç Kodu Insert Code Wendepplatten-Bezeichnung	Stok Stock Lager	Uç Ölçüleri (mm) Insert Dimension (mm) Abmessung (mm)					Kalite Grade Sorte
		TP	S	RE	REN	CDX	
B26.07.0234.PJx4	●	2.34	7	0.36	0.24	2.08	VK10F01
B26.07.0356.PKx4	●	3.56	7	0.45	0.35	3.35	VK10F01
B26.07.0470.PLx3	●	4.70	7	0.38	0.45	4.85	VK10F01

R: Sağ / Right / Rechts L: Sol/Left/Links

● Stokta / In Stock / Auf Lager ○ Stokta Yok / Non Stock Item / Kein Lagerartikel, Lieferzeit auf Anfrage

Sipariş Örneği/Ordering Example/Bestellbeispiel

1 ad./pcs./stück ATPVK 2020 K2.34X4



*konusulan
the spoken kalite...
quality...*

T-SİSTEM

T-SİSTEM İÇTEN SOĞUTMA KANALLI DIŞ TORNA KATERLERİ
T-SYSTEM EXTERNAL TURNING TOOLHOLDERS WITH COOLANT TOOLS
T-SYSTEM AUSSEN - DREHHALTER MIT INNENKÜHLUNG



DETAYLI BİLGİ İÇİN BARKODU OKUTUNUZ
SCAN ME FOR MORE DETAILS
SCANNEN SIE MICH NACH WEITEREN DETAILS

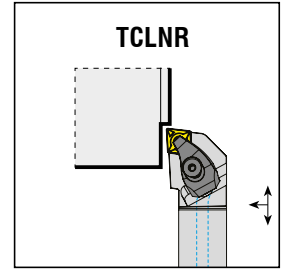
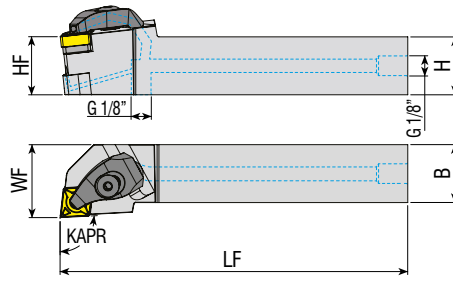

Takım Kodu
Ordering Code
Bestell-Bezeichnung

Stok Stock Lager		Takım Ölçüleri (mm) Dimension (mm) Abmessung (mm)				
R	L	HF=H	B	LF	WF	

TCLNR/L 2020 K12-H	●	●	20	20	125	25
2525 M12-H	●	●	25	25	150	32
3232 P12-H	●	●	32	32	170	40

Kesici Uç
Insert
Wendeschneidplatte



Baskı Pabuçu
Wedge Clamp
Spannpratze



Pabuç Vidası
Clamp Screw
Klemmschraube



Altlık
Shim
Unterlage



Altlık Vidası
Shim Screw
Schraube für Unterlage



Yay
Spring
Feder



Oring
Ring
Feder



Sızdırmaz Vidı
Threaded Pin
Gewindestift



Anahtar
Allen Key
Innensechskantschlüssel

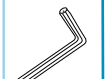

CNM. 1204..

ATKH-01-R
ATKH-02-L

AKV-33-M6x22

AACN-3-0001

AAV-02-M5x12

AKY-01

AXR-01

2705-G1/8x5.5

AAL-03-3

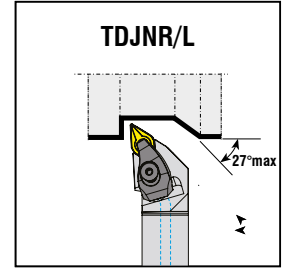
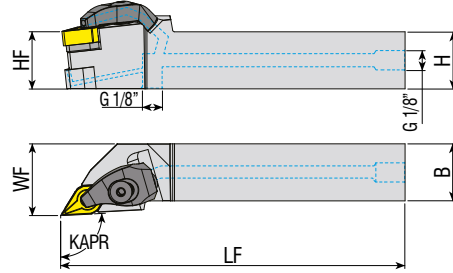

Takım Kodu
Ordering Code
Bestell-Bezeichnung

Stok Stock Lager		Takım Ölçüleri (mm) Dimension (mm) Abmessung (mm)				
R	L	HF=H	B	LF	WF	

TDJNR/L 2020 K15-H	●	●	20	20	125	25
2525 M15-H	●	●	25	25	150	32
3232 P15-H	●	●	32	32	170	40

Kesici Uç
Insert
Wendeschneidplatte



Baskı Pabuçu
Wedge Clamp
Spannpratze



Pabuç Vidası
Clamp Screw
Klemmschraube



Altlık
Shim
Unterlage



Altlık Vidası
Shim Screw
Schraube für Unterlage



Yay
Spring
Feder



Oring
Ring
Feder



Sızdırmaz Vidı
Threaded Pin
Gewindestift



Anahtar
Allen Key
Innensechskantschlüssel

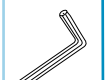

DNM. 1506..

ATKH-01-R
ATKH-01-L

AKV-33-M6x22

AADN-3-0001

AAV-02-M5x12

AKY-01

AXR-01

2705-G1/8x5.5

AAL-03-3

R: Sağ / Right / Rechts L: Sol/Left/Links

● Stokta / In Stock / Auf Lager ○ Stokta Yok / Non Stock Item / Kein Lagerartikel, Lieferzeit auf Anfrage

Sipariş Örneği/Ordering Example/Bestellbeispiel

1 ad./pcs./stück TCLNR 2020 K12-H

T-SİSTEM İÇTEN SOĞUTMA KANALLI DIŞ TORNA KATERLERİ
T-SYSTEM EXTERNAL TURNING TOOLHOLDERS WITH COOLANT TOOLS
T-SYSTEM AUSSEN - DREHHALTER MIT INNENKÜHLUNG

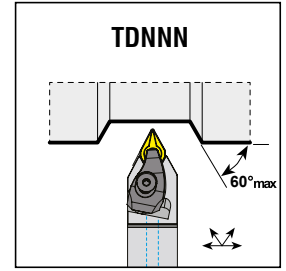
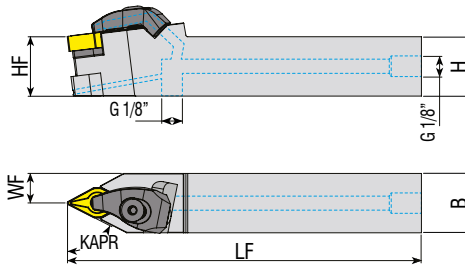

Takım Kodu Ordering Code Bestell-Bezeichnung	Stok Stock Lager		Takım Ölçüleri (mm) Dimension (mm) Abmessung (mm)				Kesici Uç Insert Wendeschneidplatte	Yedek Parçaları / Spare Parts / Ersatzteile									
	HF=H	B	LF	WF	Baskı Pabucu Wedge Clamp Spannpratze	Pabuç Vidası Clamp Screw Klemmschraube		Altlık Shim Unterlage	Altlık Vidası Shim Screw Schraube für Unterlage	Yay Spring Feder	Oring Ring Feder	Sızdırmaz Vidâ Threaded Pin Gewindestift	Anahtar Allen Key Innerschraubenschlüssel				
TDNNN 2525 M15-H	●		25	25	150	32											

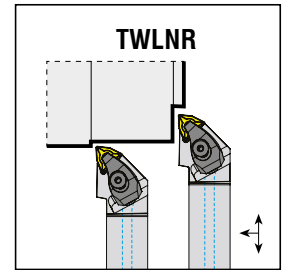
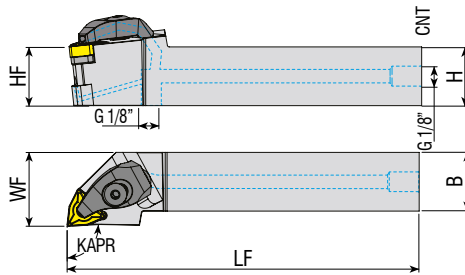

Takım Kodu Ordering Code Bestell-Bezeichnung	Stok Stock Lager		Takım Ölçüleri (mm) Dimension (mm) Abmessung (mm)				Kesici Uç Insert Wendeschneidplatte	Yedek Parçaları / Spare Parts / Ersatzteile																
	R	L	HF=H	B	LF	WF		Baskı Pabucu Wedge Clamp Spannpratze	Pabuç Vidası Clamp Screw Klemmschraube	Altlık Shim Unterlage	Altlık Vidası Shim Screw Schraube für Unterlage	Yay Spring Feder	Oring Ring Feder	Sızdırmaz Vidâ Threaded Pin Gewindestift	Anahtar Allen Key Innerschraubenschlüssel									
TWLNR/L 2020 K08-H	●	●	20	20	125	25																		
2525 M08-H	●	●	25	25	150	32										WNM. 0804..	ATKH-01-R	AKV-33-M6x22	AAWN-3-0001	AAV-02-M5x12	AKY-01	AXR-01	2705-G1/8x5.5	AAL-03-3
3232 P08-H	●	●	32	32	170	40										ATKH-02-L								

R: Sağ / Right / Rechts L: Sol/Left/Links
 ● Stokta / In Stock / Auf Lager ○ Stokta Yok / Non Stock Item / Kein Lagerartikel, Lieferzeit auf Anfrage

Sipariş Örneği/Ordering Example/Bestellbeispiel
 1 ad./pcs./stück TDNNN 2525 M15-H

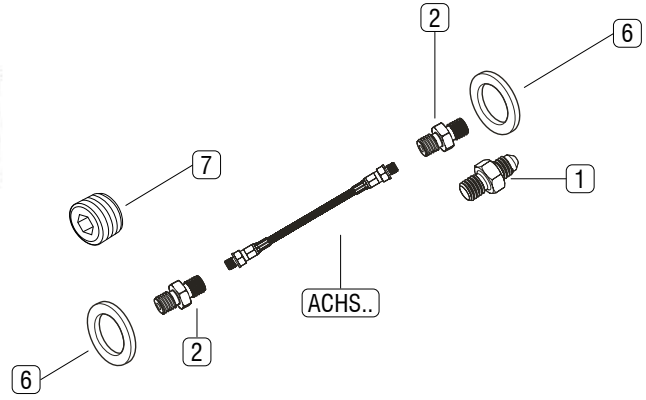
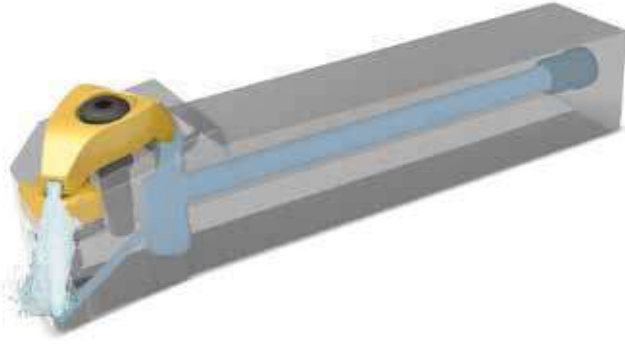

Not: İçten soğutmalı tüm torna kateerlerinde kullanılabilcek 3 tip soğutma hortum setleri tasarlanmıştır. Takımların kullanılmasından önce, kullanılmayan bağlantıların set içindeki vida ile kapatılarak sızdırmazlığın sağlanmasına dikkat edilmelidir. Torna kateerlerine yönelik soğutma hortum setleri, ACHS... 10 bar ile maksimum 275 bar basınç aralığında kullanılabilir.

Note: 3 types of cooling hose sets are designed that can be used in all internally cooled lathes. Before using the tools, care should be taken to ensure that the unused connections are closed with the screw in the set and that sealing is ensured. Cooling hose sets for lathe tools can be used in the pressure range of ACHS ... 10 bar to max 275 bar.

Notiz: Es wurden 3 Arten von Kühlschlauch-Sets entwickelt, die in allen intern gekühlten Drehmaschinen verwendet werden können. Vor der Verwendung der Werkzeuge sollte darauf geachtet werden, dass die nicht verwendeten Verbindungen mit der Schraube im Satz geschlossen werden und die Abdichtung gewährleistet ist. Kührschlauchsätze für Drehmaschinen können im Druckbereich von ACHS ... 10 bar bis max. 275 bar eingesetzt werden.

Set İçindeki Parçalar Parts In The Set Teile im Set				Uzunluk / Length Code / Länge		
				Set Kodu: Set Code: Code Einstellen: ACHS-1-250	Set Kodu: Set Code: Code Einstellen: ACHS-2-250	Set Kodu: Set Code: Code Einstellen: ACHS-3-250
1		AMP-01	M10 Bağlantı Elemanı M10 Fastener M10 Verschluss	1x	-	-
2		AMP-02	G 1/8" Çift Bağlantı Elemanı G 1/8" Double Fastener G 1/8" Doppelverschluss	2x	1x	-
3		AMP-03	G 1/8" Açılı Bağlantısı G 1/8" Angle Connection G 1/8" Winkelverbindung	-	1x	2x
4		AMP-04	M10" Açılı Bağlantısı M10" Angle Connection M10" Winkelverbindung	-	1x	1x
5		AMP-05	G1/4"-G1/8" Kılcalma Parçası G1/4"-G1/8" Capillary Piece G1/4"-G1/8" Kapillarstück	-	1x	1x
6		AG-01	Bakır Conta Copper Gasket Kupferdichtung	2x	3x	4x
7		2705-G1/8-5.5	G1/8" Sızdırmaz Civata G1/8" Sealing Bolt G1/8" Dichtungsschraube	1x	1x	1x
8		AH-1-250	Hortum Hose Schlauch	1x	-	-
9		AH-2-250	Hortum Hose Schlauch	-	1x	-
10		AH-3-250	Hortum Hose Schlauch	-	-	1x



*konusulan
the spoken kalite...
quality...*

P-SİSTEM

P-SİSTEM İÇTEN SOĞUTMA KANALLI DIŞ TORNA KATERLERİ
P-SYSTEM EXTERNAL TURNING TOOLHOLDERS WITH COOLANT TOOLS
P-SYSTEM AUSSEN - DREHHALTER MIT INNENKÜHLUNG



DETAYLI BİLGİ İÇİN BARKODU OKUTUNUZ
SCAN ME FOR MORE DETAILS
SCANNEN SIE MICH NACH WEITEREN DETAILS

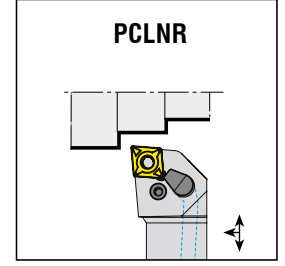
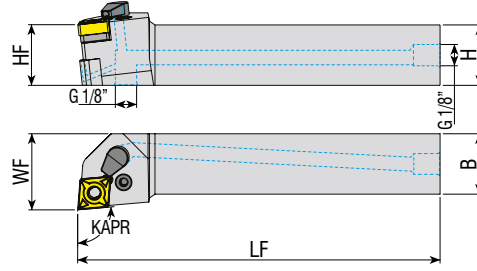

Takım Kodu Ordering Code Bestell-Bezeichnung	Stok Stock Lager		Takım Ölçüleri (mm) Dimension (mm) Abmessung (mm)				Kesici Uç Insert Wendeschneidplatte	Levyeye Lever Kniehebel	Levyeye Vidası Lever Screw Kniehebelschraube	Altılık Shim Unterlage	Altılık Yayı Shim Spring Feder für Unterlage	Oring Ring Feder	Sızdırmaz Vida Threaded Pin Gewindestift	Nozzle Nozzle Nozzle	Anahtar Allen Key Innensechskantschlüssel
	R	L	HF=H	B	LF	WF									
PCLNR/L 2020 K12-H	●	●	20	20	125	25	CNM. 1204..	APL-02	ALV-03-M8x19	AACN-3-0001	AAY-02	AXR-01 AOR-01	2705-G1/8x5.5	AN-01	AAL-03-3
2525 M12-H	●	●	25	25	150	32									
3232 P12-H	●	○	32	32	170	40									

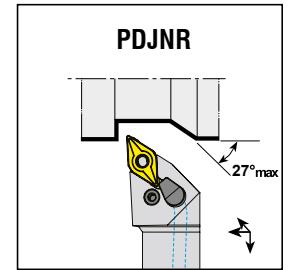
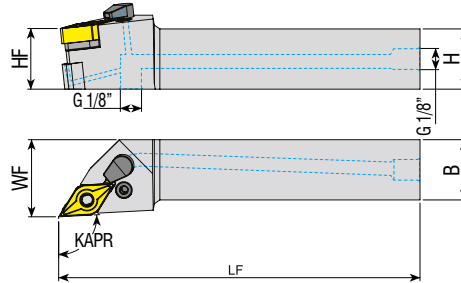

Takım Kodu Ordering Code Bestell-Bezeichnung	Stok Stock Lager		Takım Ölçüleri (mm) Dimension (mm) Abmessung (mm)				Kesici Uç Insert Wendeschneidplatte	Levyeye Lever Kniehebel	Levyeye Vidası Lever Screw Kniehebelschraube	Altılık Shim Unterlage	Altılık Yayı Shim Spring Feder für Unterlage	Oring Ring Feder	Sızdırmaz Vida Threaded Pin Gewindestift	Nozzle Nozzle Nozzle	Anahtar Allen Key Innensechskantschlüssel
	R	L	HF=H	B	LF	WF									
PDJNR/L 2020 K15-H	●	●	20	20	125	25	DNM. 1506..	APL-03	ALV-03-M8x19	AADN-3-0001	AAY-02	AXR-01 AOR-01	2705-G1/8x5.5	AN-01	AAL-03-3
2525 M15-H	●	●	25	25	150	32									
3232 P15-H	●	○	32	32	170	40									

R: Sağ / Right / Rechts L: Sol/Left/Links
● Stokta / In Stock / Auf Lager ○ Stokta Yok / Non Stock Item / Kein Lagerartikel, Lieferzeit auf Anfrage

Sipariş Örneği/Ordering Example/Bestellbeispiel
1 ad./pcs./stück PCLNR 2020 K12-H



new

KAPR=62.5°

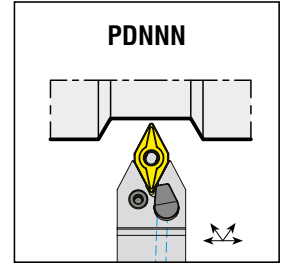
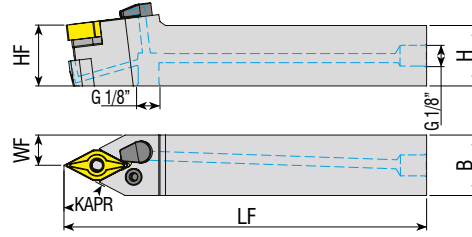

Takım Kodu
Ordering Code
Bestell-Bezeichnung

Stok
Stock
Lager

Takım Ölçüleri (mm)
Dimension (mm)
Abmessung (mm)

Kesici Uç
Insert
Wendeschneidplatte

Levyeye
Lever
Kniehebel

Levyeye Vidası
Lever Screw
Kniehebelschraube

Altılık
Shim
Unterlage

Altılık Yay
Shim Spring
Feder für Unterlage

Oring
Ring
Feder

Sızdırmaz Vida
Threaded Pin
Gewindestift

Nozzle
Nozzle
Nozzle

Anahtar
Allen Key
Innensechskantschlüssel

Yedek Parçaları / Spare Parts / Ersatzteile

HF=H B LF WF

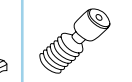

PDNNN 2525 M15-H

●

25

25

150

32

DNM. 1506..

APL-03

ALV-03-M8x19

AADN-3-0001

AAY-02

AXR-01
AOR-01

2705-G1/8x5.5

AN-01

AAL-03-3

new

KAPR=95°

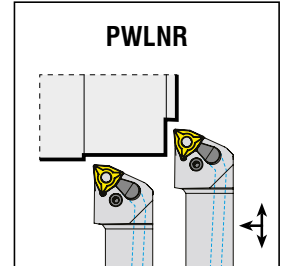
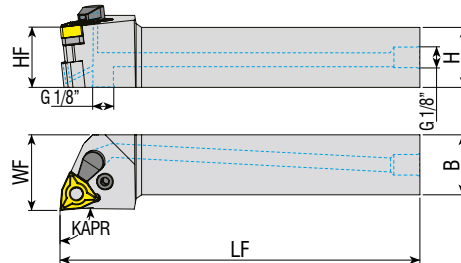

Takım Kodu
Ordering Code
Bestell-Bezeichnung

Stok
Stock
Lager

Takım Ölçüleri (mm)
Dimension (mm)
Abmessung (mm)

Kesici Uç
Insert
Wendeschneidplatte

Levyeye
Lever
Kniehebel

Levyeye Vidası
Lever Screw
Kniehebelschraube

Altılık
Shim
Unterlage

Altılık Yay
Shim Spring
Feder für Unterlage

Oring
Ring
Feder

Sızdırmaz Vida
Threaded Pin
Gewindestift

Nozzle
Nozzle
Nozzle

Anahtar
Allen Key
Innensechskantschlüssel

Yedek Parçaları / Spare Parts / Ersatzteile

R L HF=H B LF WF

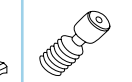

PWLNR/L 2020 K08-H

● ●

20

20

125

25

WNM. 0804..

APL-02

ALV-03-M8x19

AAWN-3-0001

AAY-02

AXR-01
AOR-01

2705-G1/8x5.5

AN-01

AAL-03-3

2525 M08-H

● ●

25

25

150

32

R: Sağ / Right / Rechts L: Sol/Left/Links

● Stokta / In Stock / Auf Lager ○ Stokta Yok / Non Stock Item / Kein Lagerartikel, Lieferzeit auf Anfrage

Sipariş Örneği/Ordering Example/Bestellbeispiel

1 ad./pcs./stück PDNNN 2525 M15-H



www.akko.com.tr

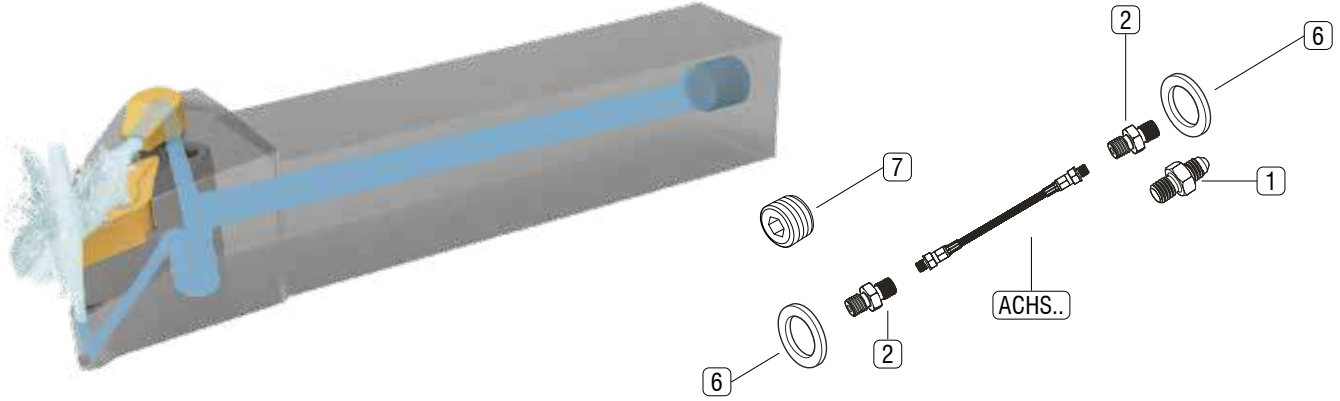

Not: İçten soğutmalı tüm torna kateerlerinde kullanılabilir 3 tip soğutma hortum setleri tasarlanmıştır. Takımların kullanılmasından önce, kullanılmayan bağlantıların set içindeki vida ile kapatılarak sızdırmazlığın sağlanmasına dikkat edilmelidir. Torna kateerlerine yönelik soğutma hortum setleri, ACHS... 10 bar ile maksimum 275 bar basınç aralığında kullanılabilir.

Note: 3 types of cooling hose sets are designed that can be used in all internally cooled lathes. Before using the tools, care should be taken to ensure that the unused connections are closed with the screw in the set and that sealing is ensured. Cooling hose sets for lathe tools can be used in the pressure range of ACHS ... 10 bar to max 275 bar.

Notiz: Es wurden 3 Arten von Kühlschlauch-Sets entwickelt, die in allen intern gekühlten Drehmaschinen verwendet werden können. Vor der Verwendung der Werkzeuge sollte darauf geachtet werden, dass die nicht verwendeten Verbindungen mit der Schraube im Satz geschlossen werden und die Abdichtung gewährleistet ist. Kühlschlauchsätze für Drehmaschinen können im Druckbereich von ACHS ... 10 bar bis max. 275 bar eingesetzt werden.

Set İçindeki Parçalar Parts In The Set Teile im Set				Uzunluk / Length Code / Länge		
				Set Kodu: Set Code: Code Einstellen: ACHS-1-250	Set Kodu: Set Code: Code Einstellen: ACHS-2-250	Set Kodu: Set Code: Code Einstellen: ACHS-3-250
1		AMP-01	M10 Bağlantı Elemanı M10 Fastener M10 Verschluss	1x	-	-
2		AMP-02	G 1/8" Çift Bağlantı Elemanı G 1/8" Double Fastener G 1/8" Doppelverschluss	2x	1x	-
3		AMP-03	G 1/8" Açılı Bağlantısı G 1/8" Angle Connection G 1/8" Winkelverbindung	-	1x	2x
4		AMP-04	M10" Açılı Bağlantısı M10" Angle Connection M10" Winkelverbindung	-	1x	1x
5		AMP-05	G1/4"-G1/8" Kısalma Parçası G1 / 4"-G1/8" Capillary Piece G1 / 4"-G1/8" Kapillarstück	-	1x	1x
6		AG-01	Bakır Conta Copper Gasket Kupferdichtung	2x	3x	4x
7		2705-G1/8-5.5	G1/8" Sızdırmaz Cıvata G1/8" Sealing Bolt G1/8" Dichtungsschraube	1x	1x	1x
8		AH-1-250	Hortum Hose Schlauch	1x	-	-
9		AH-2-250	Hortum Hose Schlauch	-	1x	-
10		AH-3-250	Hortum Hose Schlauch	-	-	1x







*konusulan
the spoken kalite...
quality...*

S-SİSTEM

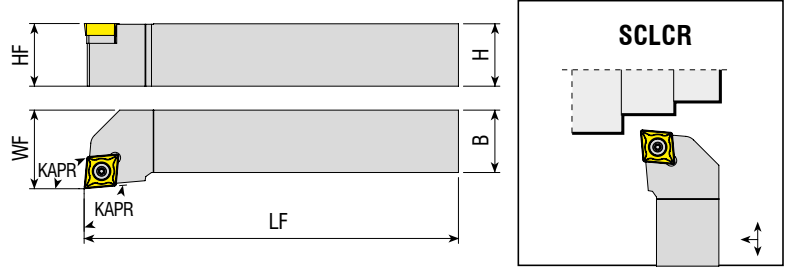

S-SİSTEM DIŞ TORNA KATERLERİ
S-SYSTEM EXTERNAL TURNING TOOLHOLDERS
S-SYSTEM AUSSEN - DREHHALTER



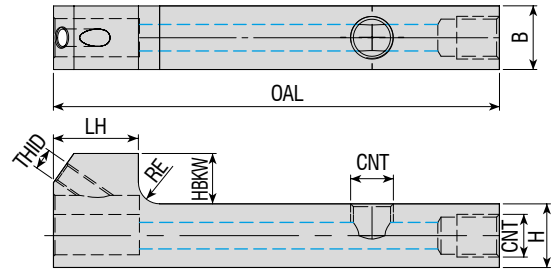

Takım Kodu Ordering Code Bestell-Bezeichnung	Stok Stock Lager		Takım Ölçüleri (mm) Dimension (mm) Abmessung (mm)				Kesici Uç Insert Wendeschneidplatte	Yedek Parçaları / Spare Parts / Ersatzteile			
	R	L	HF=H	B	LF	WF		Sıkma Vidası Screw Schraube	Altık Shim Unterlage	Altık Vidası Shim Screw Schraube für Unterlage	Tork Anahtar Torx Key Torx-Schlüssel
SCLCR/L 1212 F06	●	●	12	12	80	16			-	-	



Takım Kodu Ordering Code Bestell-Bezeichnung	Stok Stock Lager	Takım Ölçüleri (mm) Dimension (mm) Abmessung (mm)								Yedek Parçaları / Spare Parts / Ersatzteile		
		H	B	RE	HBKW	LH	OAL	CNT	THID	Sızdırmaz Vida Threaded Pin Gewindestift	Montaj Vidası Mounting Screw Befestigungsschraube	Anahtar Allen Key Innensechskantschlüssel
ASTB-1212-L84-H	●	12	12	4	9.5	16	84	M8X1X5	M4x0.7			
ASTB-1616-L90-H	●	16	16	1	5.5	16	90	M8X1X5	M4x0.7			



KAPR=93°

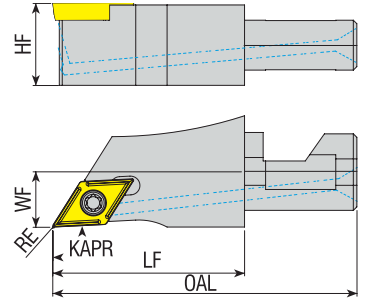

Takım Kodu
Ordering Code
Bestell-Bezeichnung

Stok
Stock
Lager

Takım Ölçüleri (mm)
Dimension (mm)
Abmessung (mm)

Kesici Uç
Insert
Wendeschneidplatte

Yedek Parçaları / Spare Parts / Ersatzteile

Sıkma Vidası
Screw
Schraube

Tork Anahtar
Torx Key
Torx-Schlüssel

R

L

HF

WF

RE

LF

OAL

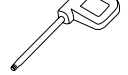

SDJCR/L-12X43.3-07

●

●

11.8

8

0.2

27.3

43.3

12X43.3-07-H

●

●

11.8

8

0.2

27.3

43.3

16X43.3-07

●

●

15.8

8

0.2

27.3

43.3

16X43.3-07-H

●

●

15.8

8

0.2

27.3

43.3

12X43.3-11

●

●

11.8

8

0.2

27.3

43.3

12X43.3-11-H

●

●

11.8

8

0.2

27.3

43.3

16X43.3-11

●

●

15.8

8

0.2

27.3

43.3

16X43.3-11-H

●

●

15.8

8

0.2

27.3

43.3

DC.T 070202

4008-M2.5x6

80-T08

DC.T 11T302

4015-M3.5x11

80-T15



KAPR=93°

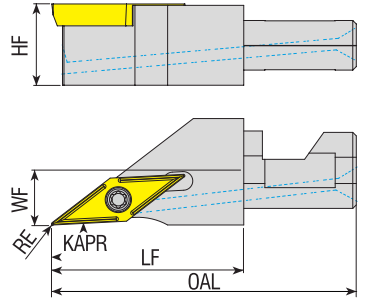

Takım Kodu
Ordering Code
Bestell-Bezeichnung

Stok
Stock
Lager

Takım Ölçüleri (mm)
Dimension (mm)
Abmessung (mm)

Kesici Uç
Insert
Wendeschneidplatte

Yedek Parçaları / Spare Parts / Ersatzteile

Sıkma Vidası
Screw
Schraube

Tork Anahtar
Torx Key
Torx-Schlüssel

R

L

HF

WF

RE

LF

OAL

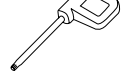

SVJCR/L-12X43.3-11

●

●

11.8

8

0.2

27.3

43.3

12X43.3-11-H

●

●

11.8

8

0.2

27.3

43.3

16X43.3-11

●

●

15.8

8

0.2

27.3

43.3

16X43.3-11-H

●

●

15.8

8

0.2

27.3

43.3

VC.T 110302

4008-M2.5x6

80-T08

R: Sağ / Right / Rechts L: Sol/Left/Links

● Stokta / In Stock / Auf Lager ○ Stokta Yok / Non Stock Item / Kein Lagerartikel, Lieferzeit auf Anfrage

Sipariş Örneği/Ordering Example/Bestellbeispiel

1 ad./pcs./stück SDJCR-12X43.3-07

new

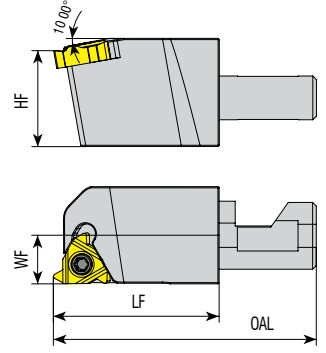

Takım Kodu
Ordering Code
Bestell-Bezeichnung

Stok Stock Lager		Takım Ölçüleri (mm) Dimension (mm) Abmessung (mm)					Kesici Uç Insert Wendeschneidplatte	Yedek Parçaları / Spare Parts / Ersatzteile					
		R	L	OAL	LF	WF		HF	Sıkma Vidası Screw Schraube	Sağ Altlık Right Shim U-Platte für WSP rechts	Sol Altlık Left Shim U-Platte für WSP links	Altlık Vidası Shim Screw Schraube für Unterlage	Altlık Vidası Pulu Shim Screw Ring Schraube für Unterlagerung
SER/L-12x43.3-11	● ●	43.3	27.3	8	11.8			-	-	-	-	80-T08	
SER/L-16x43.3-11	● ●	43.3	27.3	8	15.8	11 ER/EL	4008-M2.5x6	-	-	-	-	80-T08	
TER/L-16x43.3-16	● ●	43.3	27.3	8	15.8	16 ER/EL	1710-U5-40x12.2	ATS-16E	ATS-16I	AAV-11-U5-40x4.5	ABPL-03	80-T10	



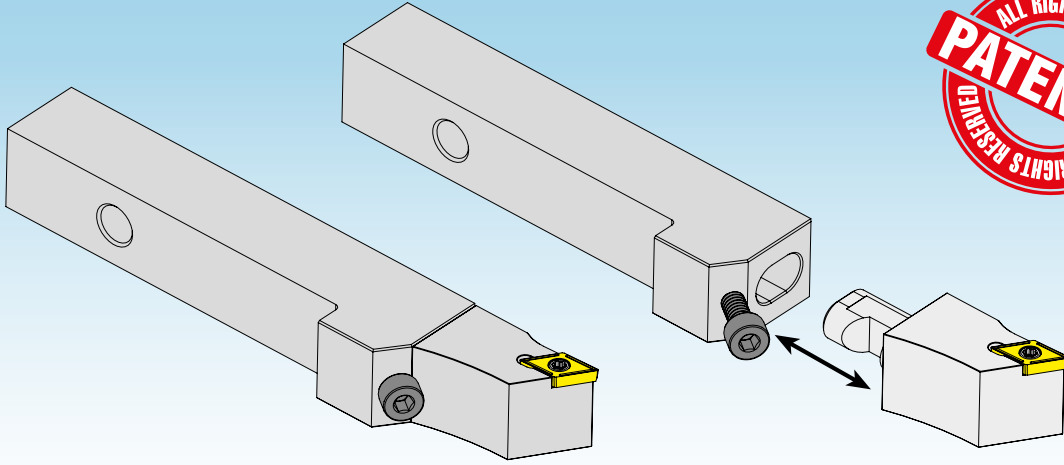

Takım tutucuyu, bağlama ünitesinden sökme zorunluğ u kalmadan hızlıca değ iş tirin!

Quick change, without having to remove the tool-holder from the gang !

Es ist nicht nötig, den Grundhalter vom Werkzeugträger zu entfernen schnelle wechsel möglich!

Makina dış ında ön ayar yapmak mümkün.

Presetting is possible outside of the machine.

Voreinstellung ausserhalb der Maschine ist möglich.

Çok hassas montaj.

Ultra precise fitting.

Ultra-präziser Montage.

Rijit sabitleme.

Rigid fixation.

Starre Befestigung.

Takım tutucu bölümü: 12x12 ve 16x16 mm.

Tool-holder section : 12x12 and 16x16 mm.

Grundhalter: 12x12 und 16x16mm.

Sağ ve sol uç lar kullanılır.

Left and right inserts available.

Links und Rechts WSP verwendbar.

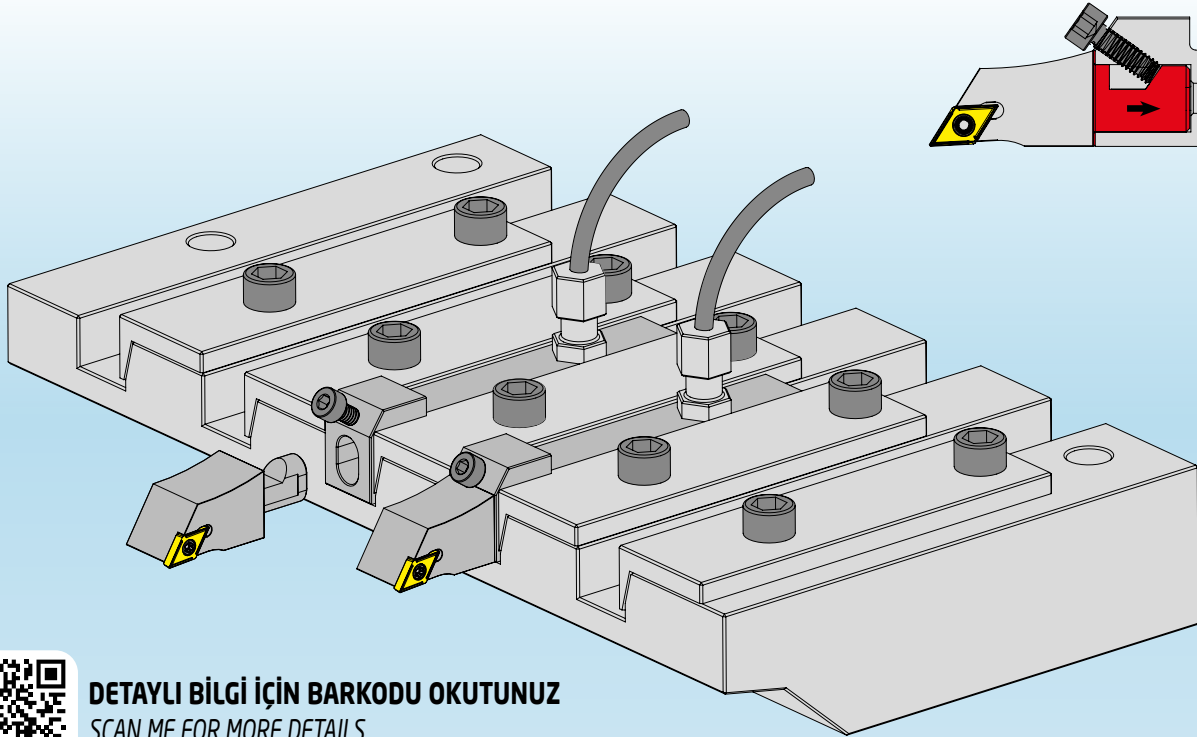

DETAYLI BİLGİ İÇİN BARKODU OKUTUNUZ

SCAN ME FOR MORE DETAILS

SCANNEN SIE MICH NACH WEITEREN DETAILS

DELİK TORNA TAKIMLARI
INTERNAL TURNING TOOLHOLDERS
DREHWERKZEUGE FÜR DIE INNENBEARBEITUNG





*konusulan
the spoken kalite...
quality...*

P-SİSTEM

P-SİSTEM DELİK TORNA KATERLERİ
P-SYSTEM BORING BARS
P- SYSTEM BOHRSTANGE





KAPR=95°

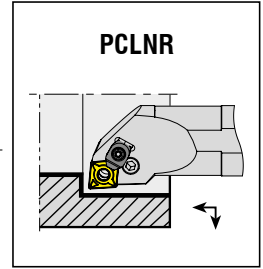
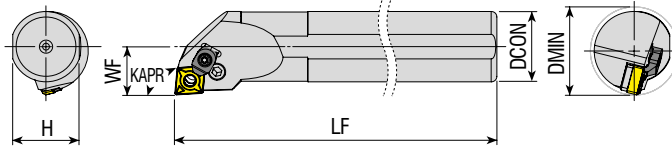

Takım Kodu
Ordering Code
Bestell-Bezeichnung

Stok Stock Lager	Takım Ölçüleri (mm) Dimension (mm) Abmessung (mm)							Kesici Uç Insert Wendeschneidplatte	Yedek Parçaları / Spare Parts / Ersatzteile						
	R	L	DCON	H	LF	WF	DMIN		Levyeye Lever Kniehebel	Levyeye Vidası Lever Screw Kniehebelschraube	Altılık Shim Unterlage	Altılık Yayılı Shim Spring Feder für Unterlage	Baskı Pabucu Wedge Clamp Spannpratze	Pabuç Vidası Clamp Screw Klemmschraube	Anahtar Allen Key Innerschlüssel
A20P PCLNR/L 09	●	●	20	18.3	170	13	≥25	CNM. 0903..	APL-01	ALV-02-M6x17	AACN-2-0002	AAAY-01	-	-	AAL-02-2.5



KAPR=93°

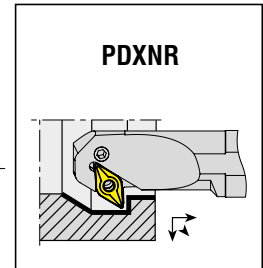
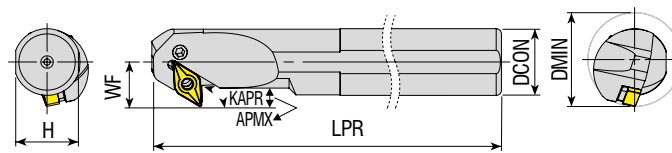

Takım Kodu
Ordering Code
Bestell-Bezeichnung

Stok Stock Lager	Takım Ölçüleri (mm) Dimension (mm) Abmessung (mm)							Kesici Uç Insert Wendeschneidplatte	Yedek Parçaları / Spare Parts / Ersatzteile							
	R	L	DCON	H	LPR	WF	APMX		DMIN	Levyeye Lever Kniehebel	Levyeye Vidası Lever Screw Kniehebelschraube	Altılık Shim Unterlage	Altılık Yayılı Shim Spring Feder für Unterlage	Baskı Pabucu Wedge Clamp Spannpratze	Pabuç Vidası Clamp Screw Klemmschraube	Anahtar Allen Key Innerschlüssel
A32S PDXNR/L 15	●	●	32	30	250	22	12	≥40	DNM. 1506..	APL-03	ALV-08-M8x16	AADN-3-0001	AAAY-02	-	-	AAL-03-3
A40T PDXNR/L 15	●	●	40	37.5	300	27	14	≥50								
A50U PDXNR/L 15	●	●	50	47	350	35	19	≥63								

R: Sağ / Right / Rechts L: Sol/Left/Links

● Stokta / In Stock / Auf Lager ○ Stokta Yok / Non Stock Item / Kein Lagerartikel, Lieferzeit auf Anfrage

Sipariş Örneği/Ordering Example/Bestellbeispiel

1 ad./pcs./stück S16P PCLNR 09



KAPR=75°

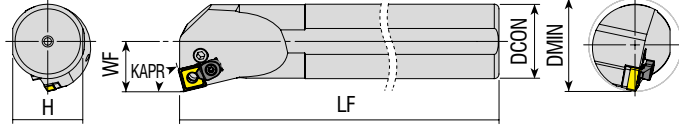

PSKNR

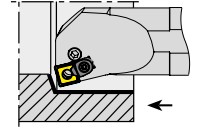

Takım Kodu Ordering Code Bestell-Bezeichnung	Stok Stock Lager		Takım Ölçüleri (mm) Dimension (mm) Abmessung (mm)					Kesici Uç Insert Wendeschneidplatte	Yedek Parçaları / Spare Parts / Ersatzteile						
	R	L	DCON	H	LF	WF	DMIN		Levyeye Lever Kniehebel	Levyeye Vidası Lever Screw Kniehebelschraube	Altılık Shim Unterlage	Altılık Yayını Shim Spring Feder für Unterlage	Baskı Pabuçunu Wedge Clamp Spannpratze	Pabuç Vidasını Clamp Screw Klemmschraube	Anahtar Allen Key Innensechskantschlüssel
A25R PSKNR/L 12C	●	●	25	23	200	17	≥32	SNM. 1204..	APL-02	ALV-08-M8x16	AASN-3-0004	AAAY-02	ACK-05	4015-M4x11	AAL-03-3
A32S PSKNR/L 12C	●	●	32	30	250	22	≥40								
A40T PSKNR/L 12C	●	●	40	37.5	300	27	≥50								
A50U PSKNR/L 12C	○	●	50	47	350	35	≥63								
A32S PSKNR/L 15C	●	●	32	30	250	22	≥40	SNM. 1506..	APL-04	ALV-04-M8x22	AASN-3-0023	AAAY-03	ACK-09	AAV-05-M6x15	AAL-03-3
A40T PSKNR/L 15C	●	●	40	37.5	300	27	≥50								
A50U PSKNR/L 15C	●	●	50	47	350	35	≥63								



KAPR=90°

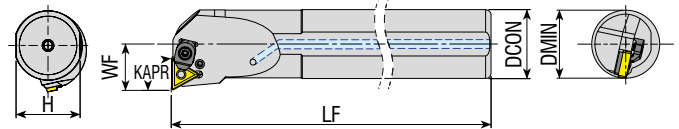

PTFNR

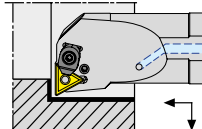

Takım Kodu Ordering Code Bestell-Bezeichnung	Stok Stock Lager		Takım Ölçüleri (mm) Dimension (mm) Abmessung (mm)					Kesici Uç Insert Wendeschneidplatte	Yedek Parçaları / Spare Parts / Ersatzteile						
	R	L	DCON	H	LF	WF	DMIN		Levyeye Lever Kniehebel	Levyeye Vidası Lever Screw Kniehebelschraube	Altılık Shim Unterlage	Altılık Yayını Shim Spring Feder für Unterlage	Baskı Pabuçunu Wedge Clamp Spannpratze	Pabuç Vidasını Clamp Screw Klemmschraube	Anahtar Allen Key Innensechskantschlüssel
A25R PTFNR/L 16C	●	●	25	23	200	17	≥32	TNM. 1604..	APL-01	ALV-02-M6x17	AATN-3-0025	AAAY-01	ACK-05	4015-M4x11	AAL-03-3
A32S PTFNR/L 16C	●	●	32	30	250	22	≥40								

R: Sağ / Right / Rechts L: Sol/Left/Links

● Stokta / In Stock / Auf Lager ○ Stokta Yok / Non Stock Item / Kein Lagerartikel, Lieferzeit auf Anfrage

Sipariş Örneği/Ordering Example/Bestellbeispiel

1 ad./pcs./stück A25R PSKNR 12C



KAPR=95°

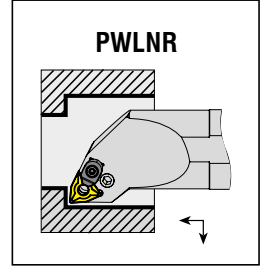
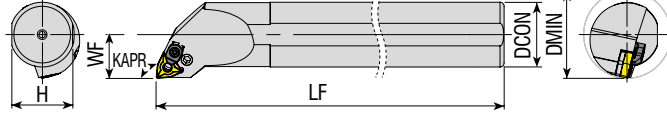

Takım Kodu Ordering Code Bestell-Bezeichnung	Stok Stock Lager		Takım Ölçüleri (mm) Dimension (mm) Abmessung (mm)					Kesici Uç Insert Wendeschneidplatte	Yedek Parçaları / Spare Parts / Ersatzteile						
	R	L	DCON	H	LF	WF	DMIN		Levyeye Lever Kniehebel	Levyeye Vidası Lever Screw Kniehebelschraube	Altlık Shim Unterlage	Altlık Yayı Shim Spring Feder für Unterlage	Baskı Pabuçu Wedge Clamp Spannpratze	Pabuç Vidası Clamp Screw Klemmschraube	Anahtar Allen Key Innensechskantschlüssel
A16M PwLNR/L 06	●	●	16	14.8	150	11	≥20	WNM. 0604..	APL-08	ALV-07-M6x13	-	AAY-07	-	-	AAL-02-2.5
A40T PwLNR/L 06	●	○	40	37.5	300	27	≥50		APL-01	ALV-02-M6x17	AAWN-SW317	AAY-01	-	-	AAL-02-2.5

R: Sağ / Right / Rechts L: Sol/Left/Links

● Stokta / In Stock / Auf Lager ○ Stokta Yok / Non Stock Item / Kein Lagerartikel, Lieferzeit auf Anfrage

Sipariş Örneği/Ordering Example/Bestellbeispiel

1 ad./pcs./stück A16M PwLNR 06





*konusulan
the spoken kalite...
quality...*

S-SİSTEM

S-SİSTEM DELİK TORNA KATERLERİ
S-SYSTEM BORING BARS
S-SYSTEM BOHRSTANGE





KAPR=90°

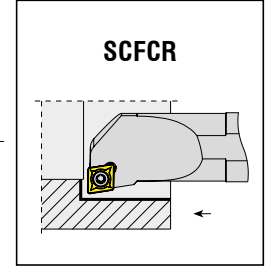
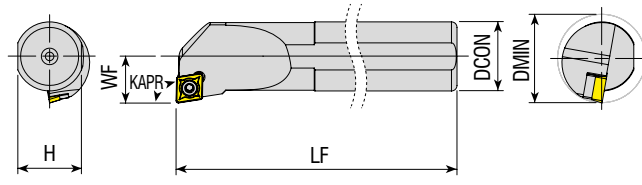

Takım Kodu
Ordering Code
Bestell-Bezeichnung

Stok
Stock
Lager

Takım Ölçüleri (mm)
Dimension (mm)
Abmessung (mm)

Kesici Uç
Insert
Wendeschneidplatte

Sıkma Vidası
Screw
Schraube

Altlık
Shim
Unterlage

Altlık Vidası
Shim Screw
Schraube für Unterlage

Tork Anahtar
Torx Key
Torx-Schlüssel

Yedek Parçaları / Spare Parts / Ersatzteile

R L DCON H LF WF DMIN



A08H SCFCR/L 06

● ○ 08 7.3 100 06 ≥11

CC.T 0602..

4008-M2.5x6

-

-

80-T08

R: Sağ / Right / Rechts L: Sol/Left/Links

● Stokta / In Stock / Auf Lager ○ Stokta Yok / Non Stock Item / Kein Lagerartikel, Lieferzeit auf Anfrage

Sipariş Örneği/Ordering Example/Bestellbeispiel

1 ad./pcs./stück A08H SCFCR 06





KAPR=93°

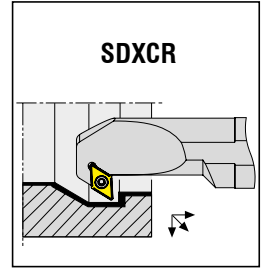
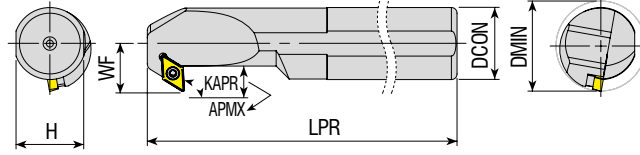

Takım Kodu
Ordering Code
Bestell-Bezeichnung

Stok
Stock
Lager

Takım Ölçüleri (mm)
Dimension (mm)
Abmessung (mm)

Kesici Uç
Insert
Wendeschneidplatte

Yedek Parçaları / Spare Parts / Ersatzteile

Sıkma Vidası
Screw
Schraube

Altlık
Shim
Unterlage

Altlık Vidası
Shim Screw
Schraube für Unterlage

Tork Anahtar
Torx Key
Torx-Schlüssel

R L DCON H LPR WF APMX DMIN

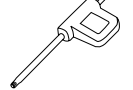

A12H SDXCR/L 07	●	●	12	11	100	09	4.5	≥16	DC.T 0702..	4008-M2.5x6	-	-	80-T08
A16M SDXCR/L 07	●	●	16	14.8	150	11	6.5	≥20					
A20P SDXCR/L 07	●	●	20	18.3	170	13	6.5	≥25					
A16M SDXCR/L 11	●	●	16	14.8	150	11	7.5	≥20	DC.T 11T3..	4015-M3.5x11	-	-	80-T15
A20P SDXCR/L 11	●	●	20	18.3	170	14	7.5	≥25					
A25R SDXCR/L 11	●	●	25	23	200	17	9	≥32					
A32S SDXCR/L 11	●	●	32	30	250	22	12.5	≥40					

R: Sağ / Right / Rechts L: Sol/Left/Links
● Stokta / In Stock / Auf Lager ○ Stokta Yok / Non Stock Item / Kein Lagerartikel, Lieferzeit auf Anfrage
Not: "APMX" ölçüleri R0.4'e göre verilmiştir.
Note: Dimensions of "APMX" are given according to R.0.4
Hinweis: Das Maß "APMX" bezieht sich auf R 0,4

Sipariş Örneği/Ordering Example/Bestellbeispiel
1 ad./pcs./stück A12H SDXCR 07

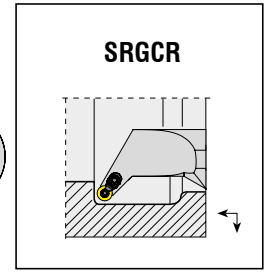
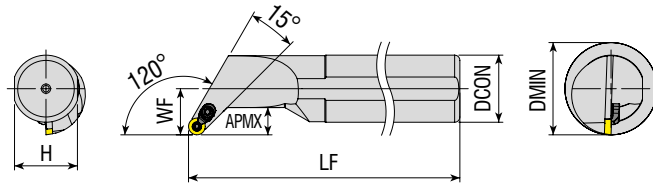

Takım Kodu Ordering Code Bestell-Bezeichnung	Stok Stock Lager		Takım Ölçüleri (mm) Dimension (mm) Abmessung (mm)					Kesici Uç Insert Wendeschneidplatte	Yedek Parçaları / Spare Parts / Ersatzteile						
	R	L	DCON	H	LF	WF	APMX		DMIN	Sıkma Vidası Screw Schraube	Altık Shim Unterlage	Altık Vidası Shim Screw Schraube für Unterlage	Baskı Pabuçu Shim Screw Spannpratze	Pabuç Vidası Shim Screw Klemmschraube	Anahtar Allen Key Innerschraubenschlüssel
A16M SRGCR/L 08	●	●	16	14.8	150	11	7	≥22	RCM. 0803..	3008-M3x8	-	-	ACK-15	4015-M3.5x11	80-T08
A20P SRGCR/L 08	●	●	20	18.3	170	13	7	≥26							
A25R SRGCR/L 08C	●	●	25	23	200	17	9.5	≥34							
A32S SRGCR/L 08C	●	●	32	30	250	22	13	≥44							
A40T SRGCR/L 08C	●	●	40	37.5	300	27	15	≥54							

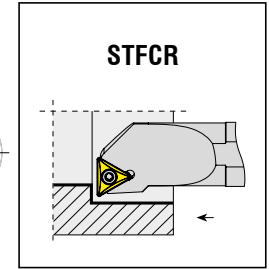
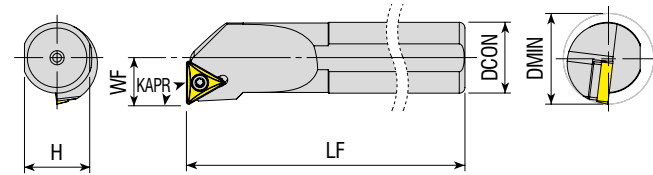

Takım Kodu Ordering Code Bestell-Bezeichnung	Stok Stock Lager		Takım Ölçüleri (mm) Dimension (mm) Abmessung (mm)					Kesici Uç Insert Wendeschneidplatte	Yedek Parçaları / Spare Parts / Ersatzteile			
	R	L	DCON	H	LF	WF	DMIN		Sıkma Vidası Screw Schraube	Altık Shim Unterlage	Altık Vidası Shim Screw Schraube für Unterlage	Tork Anahtar Torx Key Torx-Schlüssel
A10H STFCR/L 11	●	●	10	09	100	07	≥13	TC.T 1102..	4008-M2.5x6	-	-	80-T08
A12H STFCR/L 11	●	●	12	11	100	09	≥17					
A16M STFCR/L 11	●	●	16	14.8	150	11	≥20					

R: Sağ / Right / Rechts L: Sol/Left/Links

● Stokta / In Stock / Auf Lager ○ Stokta Yok / Non Stock Item / Kein Lagerartikel, Lieferzeit auf Anfrage

Sipariş Örneği/Ordering Example/Bestellbeispiel

1 ad./pcs./stück A16M SRGCR 08



KAPR=93°

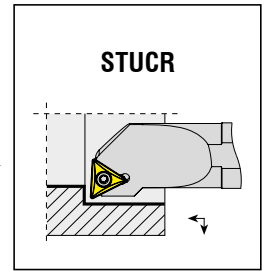
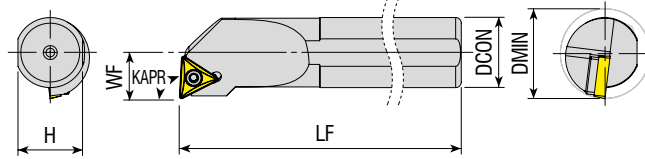

STUCR

Yedek Parçaları / Spare Parts / Ersatzteile

Takım Kodu
Ordering Code
Bestell-Bezeichnung

Stok Stock Lager	Takım Ölçüleri (mm) Dimension (mm) Abmessung (mm)							Kesici Uç Insert Wendeschneidplatte	Sıkma Vidası Screw Schraube	Altlık Shim Unterlage	Altlık Vidası Shim Screw Schraube für Unterlage	Tork Anahtar Torx Key Torx-Schlüssel
	R	L	DCON	H	LF	WF	DMIN					
								TC.T 0902..	3007-M2.2x5			80-T07
										-	-	
								TC.T 1102..	4008-M2.5x6			80-T08
								TC.T 16T3..	4015-M3.5x9 4015-M3.5x11			
											AAV-08-M3.5x8	80-T15
									4015-M3.5x14	AATN-2-0001	AAV-06-M3.5x11	



KAPR=93°

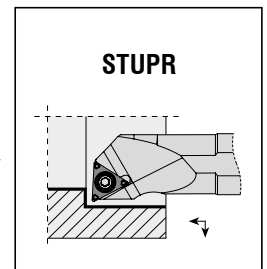
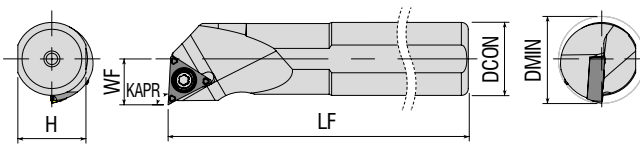

STUPR

Yedek Parçaları / Spare Parts / Ersatzteile

Takım Kodu
Ordering Code
Bestell-Bezeichnung

Stok Stock Lager	Takım Ölçüleri (mm) Dimension (mm) Abmessung (mm)							Kesici Uç Insert Wendeschneidplatte	Sıkma Vidası Screw Schraube	Altlık Shim Unterlage	Altlık Vidası Shim Screw Schraube für Unterlage	Tork Anahtar Torx Key Torx-Schlüssel
	R	L	DCON	H	LF	WF	DMIN					
								TP. 1103..	4010-M3x8			80-T10

R: Sağ / Right / Rechts L: Sol/Left/Links

● Stokta / In Stock / Auf Lager ○ Stokta Yok / Non Stock Item / Kein Lagerartikel, Lieferzeit auf Anfrage

Sipariş Örneği/Ordering Example/Bestellbeispiel

1 ad./pcs./stück A10H STUCR 09

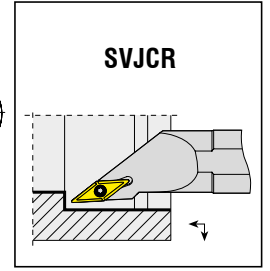
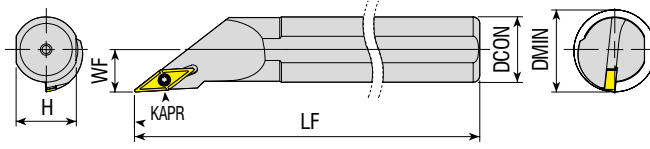

Takım Kodu
Ordering Code
Bestell-Bezeichnung

Stok Stock Lager	Takım Ölçüleri (mm) Dimension (mm) Abmessung (mm)							Kesici Uç Insert Wendeschneidplatte	Yedek Parçaları / Spare Parts / Ersatzteile			
	R	L	DCON	H	LF	WF	DMIN		Sıkma Vidası Screw Schraube	Altlık Shim Unterlage	Altlık Vidası Shim Screw Schraube für Unterlage	Tork Anahtar Torx Key Torx-Schlüssel
A12H SVJCR/L 11	●	●	12	11	100	07	≥13	VC.T 1103..	4008-M2.5x6	-	-	80-T08
A16M SVJCR/L 11	●	●	16	14.8	150	11	≥20					
A20P SVJCR/L 11	●	●	20	18.3	170	13	≥25					

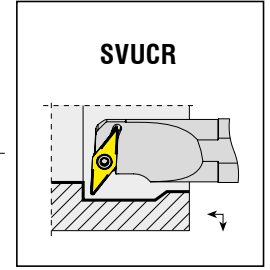
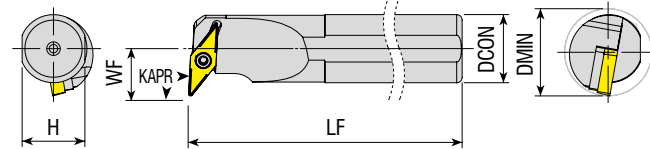

Takım Kodu
Ordering Code
Bestell-Bezeichnung

Stok Stock Lager	Takım Ölçüleri (mm) Dimension (mm) Abmessung (mm)							Kesici Uç Insert Wendeschneidplatte	Yedek Parçaları / Spare Parts / Ersatzteile			
	R	L	DCON	H	LF	WF	DMIN		Sıkma Vidası Screw Schraube	Altlık Shim Unterlage	Altlık Vidası Shim Screw Schraube für Unterlage	Tork Anahtar Torx Key Torx-Schlüssel
A20P SVUCR/L 11	●	○	20	18.3	170	13	≥25	VC.T 1103..	4008-M2.5x6	-	-	80-T08

R: Sağ / Right / Rechts L: Sol/Left/Links

● Stokta / In Stock / Auf Lager ○ Stokta Yok / Non Stock Item / Kein Lagerartikel, Lieferzeit auf Anfrage

Sipariş Örneği/Ordering Example/Bestellbeispiel

1 ad./pcs./stück A12H SVJCR 11



KAPR=107.5°

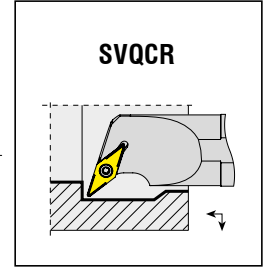
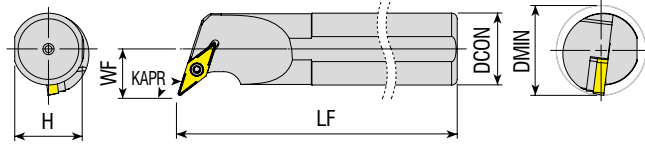

Takım Kodu
Ordering Code
Bestell-Bezeichnung

Stok Stock Lager	Takım Ölçüleri (mm) Dimension (mm) Abmessung (mm)						Kesici Uç Insert Wendeschneidplatte	Yedek Parçaları / Spare Parts / Ersatzteile				
	R	L	DCON	H	LF	WF		DMIN	Sıkma Vidası Screw Schraube	Altlık Shim Unterlage	Altlık Vidası Shim Screw Schraube für Unterlage	Tork Anahtar Torx Key Torx-Schlüssel
A16M SVQCR/L 11	●	●	16	14.8	150	11	≥20	VC.T 1103..	4008-M2.5x6	-	-	80-T08
A20P SVQCR/L 11	●	●	20	18.3	170	13	≥25	VC.T 1604..	4015-M3.5x14	AAVN-2-0002	AAV-08-M3.5x8	80-T15
A25R SVQCR/L 16	●	●	25	23	200	17	≥32				AAV-06-M3.5x11	
A32S SVQCR/L 16	●	●	32	30	250	22	≥40					
A40T SVQCR/L 16	●	●	40	37.5	300	27	≥50					



KAPR=95°

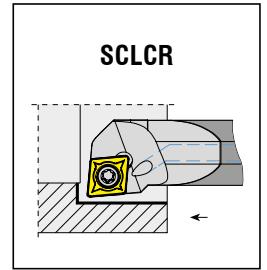
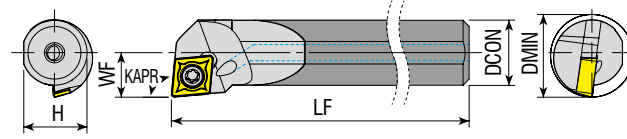

Takım Kodu
Ordering Code
Bestell-Bezeichnung

Stok Stock Lager	Takım Ölçüleri (mm) Dimension (mm) Abmessung (mm)						Kesici Uç Insert Wendeschneidplatte	Yedek Parçaları / Spare Parts / Ersatzteile				
	R	L	DCON	H	LF	WF		DMIN	Sıkma Vidası Screw Schraube	Altlık Shim Unterlage	Altlık Vidası Shim Screw Schraube für Unterlage	Tork Anahtar Torx Key Torx-Schlüssel
C06J SCLCR/L 06	●	○	6	5.7	110	4.5	≥8	CC.T 0602..	4008-M2.5x6	-	-	80-T08

R: Sağ / Right / Rechts L: Sol/Left/Links

● Stokta / In Stock / Auf Lager ○ Stokta Yok / Non Stock Item / Kein Lagerartikel, Lieferzeit auf Anfrage

Sipariş Örneği/Ordering Example/Bestellbeispiel







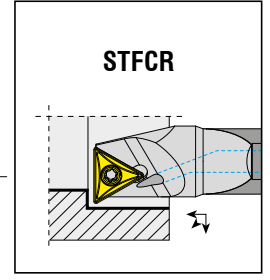
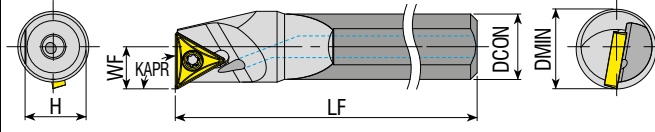



1 ad./pcs./stück A16M SVQCR 11



KAPR=90°



STFCR





Takım Kodu Ordering Code Bestell-Bezeichnung	Stok Stock Lager		Takım Ölçüleri (mm) Dimension (mm) Abmessung (mm)				Kesici Uç Insert Wendeschneidplatte	Yedek Parçaları / Spare Parts / Ersatzteile									
	R	L	DCON	H	LF	WF		DMIN	Sıkma Vidası Screw Schraube	Altlık Shim Unterlage	Altlık Vidası Shim Screw Schraube für Unterlage	Tork Anahtar Torx Key Torx-Schlüssel					
E10M STFCR/L 09	●	○	10	9.5	150	6	12	 TC.T 0902..	 3007-M2.2x5	 -	 -	 80-T07					
E12Q STFCR/L 09	●	○	12	11	180	8	15						 TC.T 1102..	 4008-M2.5x6	 -	 -	 80-T08
E12Q STFCR/L 11	●	○	12	11	180	8	15										

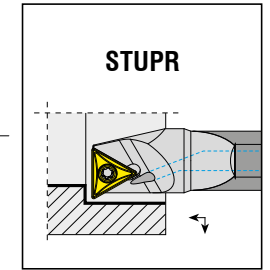
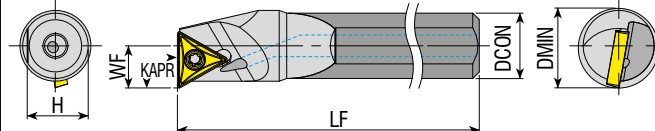

KAPR=93°



STUPR

Takım Kodu Ordering Code Bestell-Bezeichnung	Stok Stock Lager		Takım Ölçüleri (mm) Dimension (mm) Abmessung (mm)				Kesici Uç Insert Wendeschneidplatte	Yedek Parçaları / Spare Parts / Ersatzteile				
	R	L	DCON	H	LF	WF		DMIN	Sıkma Vidası Screw Schraube	Altlık Shim Unterlage	Altlık Vidası Shim Screw Schraube für Unterlage	Tork Anahtar Torx Key Torx-Schlüssel
E12Q STUPR/L 1103	●	○	12	11	180	8	15	 TP. 1103..	 4010-M3x6	 -	 -	 80-T10
E16R STUPR/L 1103	●	○	16	15	200	11	20					

R: Sağ / Right / Rechts L: Sol/Left/Links

● Stokta / In Stock / Auf Lager ○ Stokta Yok / Non Stock Item / Kein Lagerartikel, Lieferzeit auf Anfrage

Sipariş Örneği/Ordering Example/Bestellbeispiel

1 ad./pcs./stück E10M STFCR 09



konuşulan
the spoken kalite...
quality...

TIRLAMAZ

TIRLAMAZ TAKIMLAR
ANTIVIBRATION TOOLS
SCHWINGUNGSGEDÄMPFTE BOHRSTANGEN



AKKO **A** **TT** **B** **D16** **204** **10D** **H** **E**

2 Takım Tipi
Tool Type
Werkzeugtyp

Tırlamaz Takım
Anti Vibration Tool
Schwingungsgedämpfte Bohrstanze

8 Takım Malzemesi
Type of Boring Bar
Art der Bohrstanze

Karbür Takviyeli
Carbide reinforced
Hartmetall verstärkt

3 Gövde
Body
Schaft

4 Bağlantı Çapı
Connection Diameter
Anschlussdurchmesser

5 Takım Boyu
Overall length
Gesamtlänge

6 Bağlama Boyu
Overhang maximum
Maximale Auskragung

7 İçten Soğutmalı
With Coolant Hole
Mit Innenkühlung

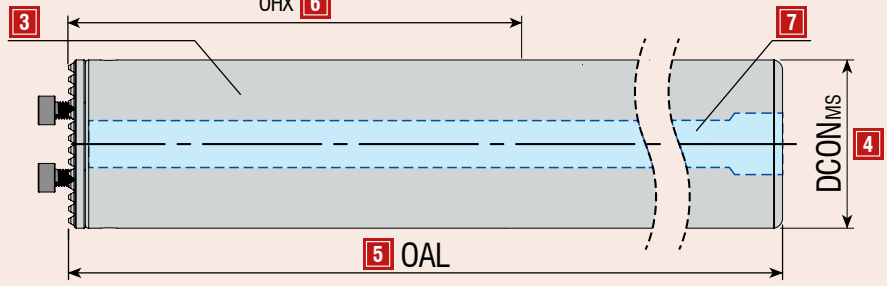

AKKO **A** **TT** **C** **A** **16** **SDUCR11**

2 Takım Tipi
Tool Type
Werkzeugtyp

Tırlamaz Takım Kartuşu
Anti Vibration Tool Cartridge
Wechselkopf für Schwingungsgedämpfte Bohrstanze

3 Kartuş Kodu
Cartridge Code
Bezeichnung für Wechselkopf

Kartuş
Cartridge
Wechselkopf

4 İçten Soğutmalı
With Coolant Hole
Mit Innenkühlung

5 Bağlama Çapı
Connection Diameter
Anschlussdurchmesser

Ø16 - Ø20 - Ø25
Ø32 - Ø40

2 Kartuş Tipi
Cartridge Type
Wechselkopftyp

SDUCR/L, SCLCR/L, SVUCR/L, TCLNR/L, TDUNR/L

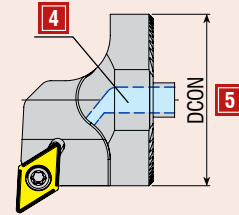

AKKO **A** **TT** **C** **16-25**

2 Takım Tipi
Tool Type
Werkzeugtyp

Tırlamaz Takım Kartuşu
Anti Vibration Tool Cartridge
Wechselkopf für Schwingungsgedämpfte Bohrstanzen

3 Kartuş
Cartridge
Wechselkopf

Merkezleme Kartuş Kodu
Centering Cartridge Code
Bezeichnung für zentriertes Wechselkopf

4 Kullanılan Gövde Çap Aralığı
Usable diameter range for body
Nutzbarer Durchmesserbereich für Werkzeugschaft

ATTB-D16/D20/D25
ATTB-D32/D40/D50/D60

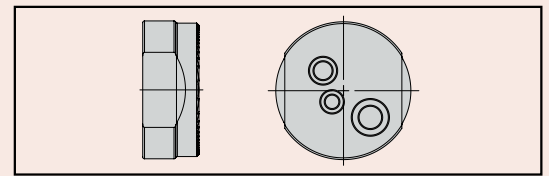

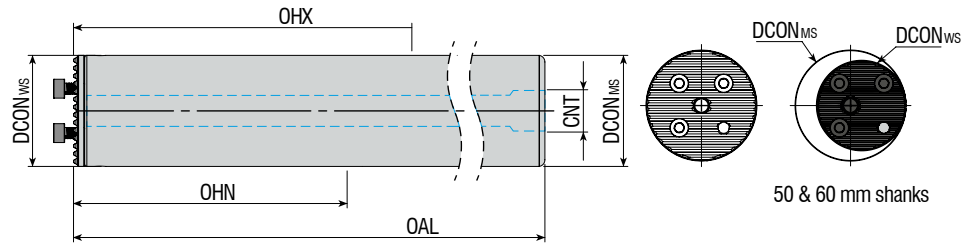

Yedek Parçaları / Spare Parts / Ersatzteile

Takım Kodu
Ordering Code
Bestell-Bezeichnung

Stok
Stock
Lager

Takım Ölçüleri (mm)
Dimension (mm)
Abmessung (mm)

Montaj Vidası
Shim Screw
Schraube für Unterlage

Montaj Vida Anahtar
Mounting Screw Key
Innensechskantschlüssel für Befestigungsschraube

Takım Kodu Ordering Code Bestell-Bezeichnung	Stok Stock Lager	DCONMS	DCONWS	OAL	OHN	OHX	CNT	DMIN		Montaj Vidası Shim Screw Schraube für Unterlage	Montaj Vida Anahtar Mounting Screw Key Innensechskantschlüssel für Befestigungsschraube
								DCON	DMIN		
ATTB-D16-156-7D-H	○	16	16	156	55	92	G1/8	16	20	2525-M3X10	AAL-02-2.5
ATTB-D16-204-10D-H-E	○	16	16	204	96	140	G1/8	16	20		
ATTB-D20-200-7D-H	○	20	20	200	70	120	G1/4	20	25	M3.5X10	AAL-03-3
ATTB-D20-260-10D-H-E	○	20	20	260	120	180	G1/4	20	25		
ATTB-D25-255-7D-H	○	25	25	255	88	158	G1/4	25	32	2503-M4X12	AAL-05-4
ATTB-D25-330-10D-H	○	25	25	330	155	230	G1/4	25	32		
ATTB-D32-320-7D-H	○	32	32	320	100	192	G3/8	32	40	2504-M5X16	AAL-07-5
ATTB-D32-416-10D-H	○	32	32	416	192	288	G3/8	32	40		
ATTB-D40-408-7D-H	○	40	40	408	128	248	G1/2	40	50	2505-M6X16	AAL-07-5
ATTB-D40-528-10D-H	○	40	40	528	248	368	G1/2	40	50		
ATTB-D50-519-7D-H	●	50	40	519	168	318	G1/2	40	63	2505-M6X16	AAL-07-5
ATTB-D50-669-10D-H	○	50	40	669	318	468	G1/2	40	63		
ATTB-D60-628-7D-H	○	60	40	628	208	388	G3/4	40	80	2505-M6X16	AAL-07-5
ATTB-D60-808-10D-H	○	60	40	808	388	568	G3/4	40	80		

R: Sağ / Right / Rechts L: Sol/Left/Links

● Stokta / In Stock / Auf Lager ○ Stokta Yok / Non Stock Item / Kein Lagerartikel, Lieferzeit auf Anfrage

Sipariş Örneği/Ordering Example/Bestellbeispiel

1 ad./pcs./stück ATTB-D16-156-7D-H





KAPR=93°

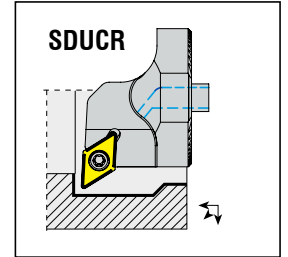
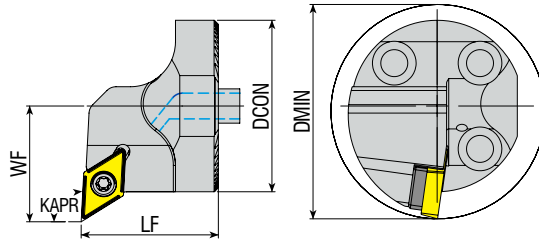

Takım Kodu Ordering Code Bestell-Bezeichnung	Stok Stock Lager		Takım Ölçüleri (mm) Dimension (mm) Abmessung (mm)				Kesici Uç Insert Wendeschneidplatte	Yedek Parçaları / Spare Parts / Ersatzteile			
	R	L	DCON	LF	WF	DMIN		Sıkma Vidası Screw Schraube	Altlık Shim Unterlage	Altlık Vidası Shim Screw Schraube für Unterlage	Tork Anahtar Torx Key Torx-Schlüssel
ATTC-A16 SDUCR/L 07	○	○	16	20	11	20	DC.T 0702..	4008-M2.5x6	-	-	80-T08
ATTC-A20 SDUCR/L 11	○	○	20	20	13	25		4015-M3.5x11	-	-	
ATTC-A25 SDUCR/L 11	○	○	25	23	17	32	DC.T 11T3..	4015-M3.5x12	-	AAV-08-M3.5x8	80-T15
ATTC-A32 SDUCR/L 11	○	○	32	32	22	40		4015-M3.5x14	AADN-2-0001	AAV-06-M3.5x11	
ATTC-A40 SDUCR/L 11	●	●	40	32	27	50		-	-	-	



KAPR=95°

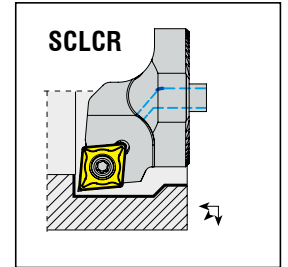
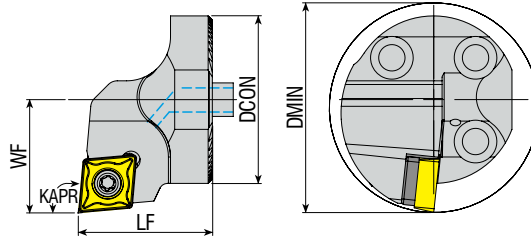

Takım Kodu Ordering Code Bestell-Bezeichnung	Stok Stock Lager		Takım Ölçüleri (mm) Dimension (mm) Abmessung (mm)				Kesici Uç Insert Wendeschneidplatte	Yedek Parçaları / Spare Parts / Ersatzteile			
	R	L	DCON	LF	WF	DMIN		Sıkma Vidası Screw Schraube	Altlık Shim Unterlage	Altlık Vidası Shim Screw Schraube für Unterlage	Tork Anahtar Torx Key Torx-Schlüssel
ATTC-A16 SCLCR/L 06	○	○	16	20	11	20	CC.T 0602..	4008-M2.5x6	-	-	80-T08
ATTC-A20 SCLCR/L 09	○	○	20	20	13	25		4015-M3.5x9	-	-	
ATTC-A25 SCLCR/L 09	○	○	25	23	17	32	CC.T 09T3..	4015-M3.5x12	AACN-2-0001	AAV-08-M3.5x8	80-T15
ATTC-A32 SCLCR/L 09	○	○	32	32	22	40		-	-	-	
ATTC-A40 SCLCR/L 12	●	●	40	32	27	50	CC.T 1204..	1020-M4.5x16	AACN-2-0003	AAV-07-M4.5x13	80-T20

R: Sağ / Right / Rechts L: Sol/Left/Links
● Stokta / In Stock / Auf Lager ○ Stokta Yok / Non Stock Item / Kein Lagerartikel, Lieferzeit auf Anfrage

Sipariş Örneği/Ordering Example/Bestellbeispiel
1 ad./pcs./stück ATTC-A16-SDUCR 07



KAPR=93°

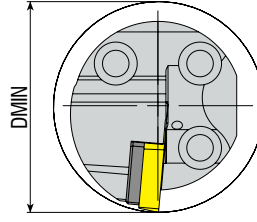
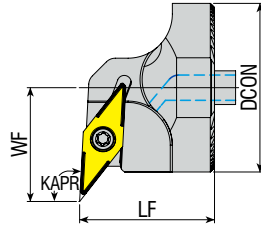

SVUCR

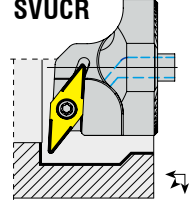

Takım Kodu Ordering Code Bestell-Bezeichnung	Stok Stock Lager		TAKIM ÖLÇÜLERİ (MM) DIMENSION (MM) ABMESSUNG (MM)				Kesici Uç Insert Wendeschneidplatte	Yedek Parçaları / Spare Parts / Ersatzteile			
	R	L	DCON	LF	WF	DMIN		SIKMA VIDASI SCREW SCHRAUBE	Altlık Shim Unterlage	Altlık Vidası Shim Screw Schraube für Unterlage	Tork Anahtar Torx Key Torx-Schlüssel
ATTC-A20 SVUCR/L 11	○	○	20	20	15	27	VC.T 1103..	4008-M2.5x6	-	-	80-T08
ATTC-A25 SVUCR/L 11	○	○	25	23	17	32					
ATTC-A32 SVUCR/L 16	○	○	32	32	22	40	VC.T 1604..	4015-M3.5x14	AAVN-2-0002	AAV-06-M3.5x11	80-T15
ATTC-A40 SVUCR/L 16	●	●	40	32	27	50					



KAPR=93°

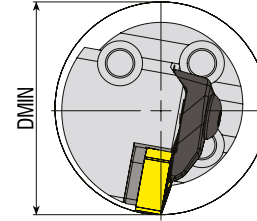
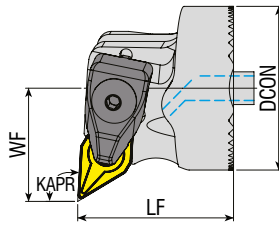

TDUNR

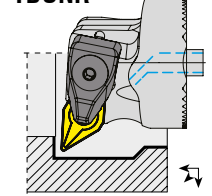

Takım Kodu Ordering Code Bestell-Bezeichnung	Stok Stock Lager		Takım Ölçüleri (mm) Dimension (mm) Abmessung (mm)				Kesici Uç Insert Wendeschneidplatte	Baskı Pabucu Wedge Clamp Spannpratze	Pabuç Vidası Clamp Screw Klemmschraube	Yedek Parçaları / Spare Parts / Ersatzteile		Sekman Ring Feder	Pul Stamp Ring	Anahtar Allen Key Innensechskantschlüssel
	R	L	DCON	LF	WF	DMIN				Altlık Shim Unterlage	Altlık Vidası Shim Screw Schraube für Unterlage			
ATTC-A32 TDUNR/L 11	○	○	32	32	22	40	DNN. 1104..	ATK-01	AKV-01-M5x22	AADN-2-0001	AAV-04-M5x12	AS-01	ABPL-01	AAL-03-3
ATTC-A40 TDUNR/L 15	●	●	40	38	27	50								

R: Sağ / Right / Rechts L: Sol/Left/Links

● Stokta / In Stock / Auf Lager ○ Stokta Yok / Non Stock Item / Kein Lagerartikel, Lieferzeit auf Anfrage

SIPARIŞ ÖRNEĞİ/ORDERING EXAMPLE/BESTELLBEISPIEL

1 AD./PCS./STÜCK ATTC-A20 SVUCR 11

TIRLAMAZ TAKIMLARIN KARTUŞLARI
ANTI VIBRATION TOOLS CARTRIDGES
WECHSELKOPF FÜR SCHWINGUNGSGEDÄMPFTE BORSTANGE



KAPR=95°

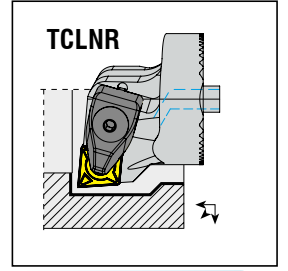
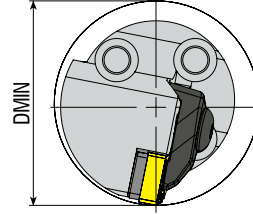
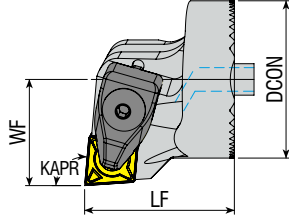

Takım Kodu Ordering Code Bestell-Bezeichnung	Stok Stock Lager		Takım Ölçüleri (mm) Dimension (mm) Abmessung (mm)				Kesici Uç Insert Wendeschneidplatte	Yedek Parçaları / Spare Parts / Ersatzteile						
	R	L	DCON	LF	WF	DMIN		Baskı Pabucu Wedge Clamp Spannpratze	Pabuç Vidası Clamp Screw Klemmschraube	Altlık Shim Unterlage	Altlık Vidası Shim Screw Schraube für Unterlage	Sekman Ring Feder	Pul Stamp Ring	Anahtar Allen Key Innerschloßschlüssel
ATTC-A32 TCLNR/L 12	○	○	32	32	22	40	CNM. 1204..							
ATTC-A40 TCLNR/L 12	●	●	40	38	27	50								

TIRLAMAZ TAKIMLARIN MERKEZLEME APARATI
ANTI VIBRATION TOOLS CENTERING INSTRUMENT
ZENTRIERWERKZEUG FÜR SCHWINGUNGSGEDÄMPFTE BORSTANGE

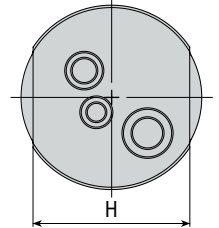
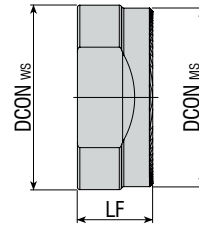

Takım Kodu Ordering Code Bestell-Bezeichnung	Stok Stock Lager	Takım Ölçüleri (mm) Dimension (mm) Abmessung (mm)				Gövde Tipi Boring Bars Art der Bohrstange
		DCONWS	DCONMS	LF	H	
ATTC-16-25	●	28	25	15	22	ATTB-D16/D20/D25
ATTC-32-60	●	53	40	20	35	ATTB-D32/D40/D50/D60

R: Sağ / Right / Rechts L: Sol/Left/Links
 ● Stokta / In Stock / Auf Lager ○ Stokta Yok / Non Stock Item / Kein Lagerartikel, Lieferzeit auf Anfrage

Sipariş Örneği/Ordering Example/Bestellbeispiel
 1 ad./pcs./stück ATTC-A32 TCLNR 12



www.akko.com.tr

1 Montaj ve Ayarlama | Assembly and Adjusting | Montage und Einstellung

Kartuş ve gövdenin montaj edilecek yüzeyleri, tutucunun iç kısmı temizlenmelidir. Aşağıdaki görselde A ve B konumlarına bakın.

The surface of the cartridge and the shank to be mounted, as well as the inner part of the toolholder should be cleaned. Check A and B in the image below.

Die Oberflächen des Wechselkopfes und des zu montierenden Schafts sowie der innere Teil des Werkzeughalters sollten gereinigt werden. Siehe A und B unten auf der Abbildung

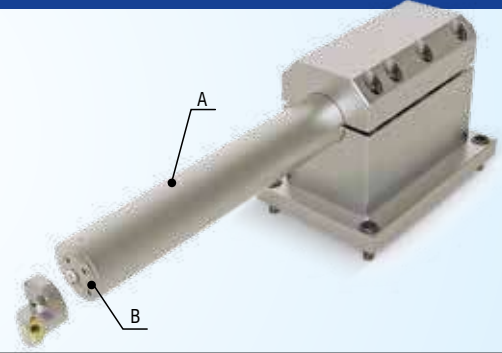

2 Gövde Montajı | Assembly for the Shank | Schaftmontage

Bağlama uzunluğu $4L/D$ oranından az olmamalıdır. Tutucunun üst kısmını çıkartma yöntemiyle veya diğer tutma sıkma yöntemleriyle kullanmanızı öneririz (C tipi). Vidalı bağlama yöntemi kullanmayın. Uzun süre çalışırken lütfen içten soğutmayı kullanın.

The clamping length should not be less than $4L/D$ ratio. Suggest using the clamping cover with opening method and other holding clamping methods. (Type C). Do not use screw clamping method. Use inner cooling please when working a long time.

Die Einspannlänge sollte nicht weniger als $4L/D$ ratio betragen. Vorgeschlagen ist die Oberseite des Halters zu öffnen und andere Halte-Klemmethoden zu verwenden. (Typ C). Bitte nicht die Schraubklemmethode verwenden. Bei langer Nutzung, bitte die Innenkühlung verwenden.

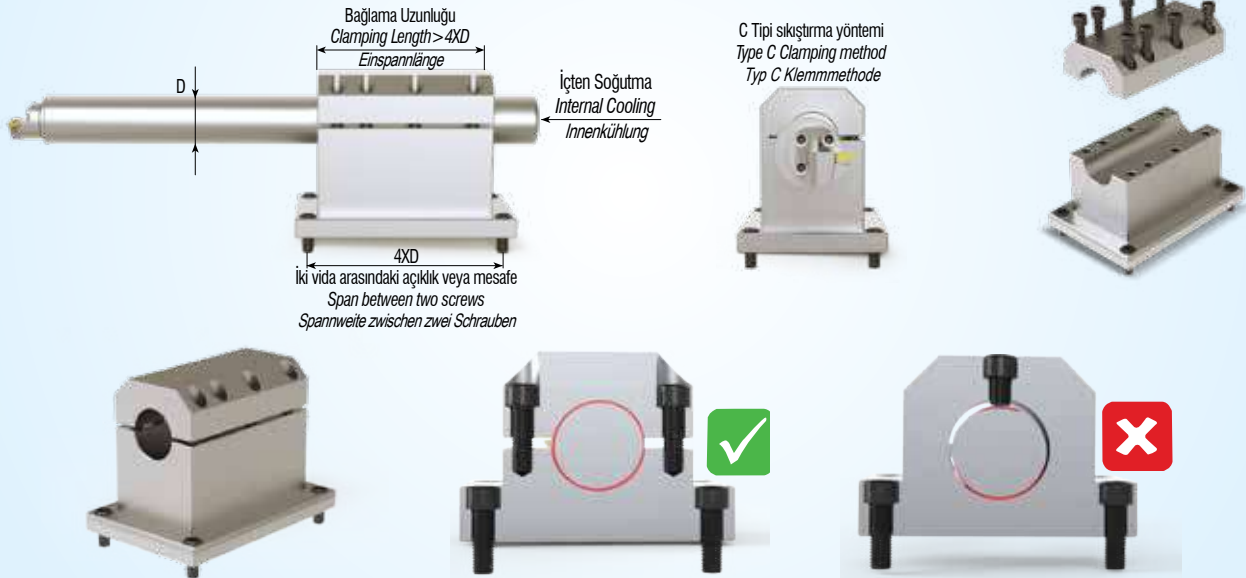

3 Merkez Yüksekliğinin Ayarlanması | Adjusting the Height of Centre Assembly | Einstellung der Zentrumhöhe

Gövdeyi ilk kez montaj ederken merkez yüksekliği için özel kalibrasyon aparatı kullanılmalıdır. Önce gövdeyi tutucuya monte edin, ardından X ekseninde 0,01 tolerans içinde kalibre edin. Lütfen komparatör saati ile ayarlamayı yapın.

When mounting the body for the first time, a special calibration tool should be used for the center height. First mount the shank on the holder, then calibrate it within 0.01 tolerance on the X axis direction. Please make the adjustment with the dial indicator device.

Bei der erstmaligen Montage des Schaftes sollte ein spezielles Kalibrierwerkzeug für die Zentrumhöhe verwendet werden. Montieren Sie zuerst den Schaft am Halter und kalibrieren Sie es dann innerhalb einer Toleranz von 0,01 in Richtung der X-Achse. Bitte benutzen Sie bei der Einstellung eine Messuhr



4 Doğru Kartuş Montajı | Assembly the Right Cartridge | Richtige Wechselkopfmontage

Yandaki şekle bakın:
See the figure on the side:
Siehe die Abbildung auf der Seite:

Sol Yön Takım
Left Hand
Linke Richtung



Sağ Yön Takım
Right Hand
Rechte Richtung



Doğru Uç Seçimi / Choosing the Correct Insert / Auswahl der richtigen Wendeschneidplatte

Doğru kesici ucun seçilmesi, titreşim sönümlenimin genel başarısı üzerinde büyük bir etkiye sahiptir. Kesici ucun işleme stabilitesini artırabilmesinin ana yolu kesme kuvvetlerini en aza indirmektir. Titreşimleri ortadan kaldırmak için aşağıdaki adımlara uymanız gerekir: Mümkünse, her zaman kısa takımları kullanın. Aksi takdirde, titreşimi en aza indirmek için hızlarınızı azaltın.

Choosing the correct insert can have a big influence on the overall success of vibration damping. The main way the insert can improve the machining stability is by minimizing the cutting forces. Following the guidelines below should be your first step to eliminate vibrations: If possible, use it always short drilling tools. Otherwise, reduce your speeds to minimize vibration.

Die Auswahl des richtigen Einsatzes kann einen großen Einfluss auf den Gesamterfolg der Schwingungsdämpfung haben. Die Wendeschneidplatte kann die Bearbeitungsstabilität hauptsächlich durch Minimierung der Schneidkräfte verbessern. Das Befolgen der folgenden Richtlinien sollte Ihr erster Schritt sein, um Vibrationen zu beseitigen: Verwenden Sie nach Möglichkeit immer kurze Werkzeuge. Reduzieren Sie andernfalls die Geschwindigkeit, um Vibrationen zu minimieren.

A Radyal kuvvetleri minimuma indirmek için mümkün olduğunca 90°'ye yakın bir giriş açılı takımı seçin.

Choose an entry angle that is as close as possible to 90° to reduce the radial forces to a minimum.

Wählen Sie einen Eintrittswinkel, der so nah wie möglich an 90° liegt, um die Radialkräfte auf ein Minimum zu reduzieren.

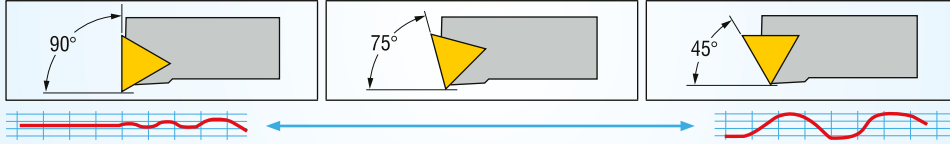

B Mümkün olan en küçük kesici uç açısını seçin. Böylece kesme kuvvetleri azalacak ve yüzey kalitesi artacak.

Choose the smallest insert head angle possible. This will reduce overall cutting forces and increase the clearance.

Wählen Sie den kleinstmöglichen Wendeschneidplattenwinkel. Damit wird sich die Gesamtschneidkraft verringern und die Klarheit verbessern.

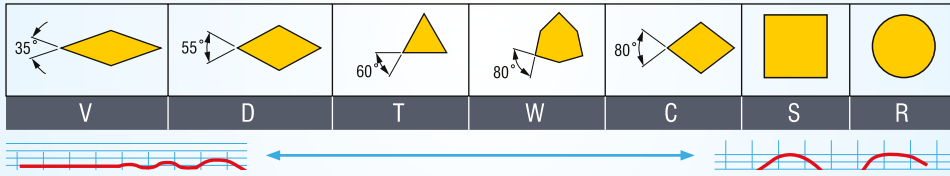

C Titreşimi azaltmak için olabildiğince en küçük radyüslü ucu seçmelisiniz.

Choose a small nose radius to reduce the cutting forces and to enable machining in a lower depth of cut.

Wählen Sie einen Eintrittswinkel, der so nah wie möglich an 90° liegt, um die Radialkräfte auf ein Minimum zu reduzieren.

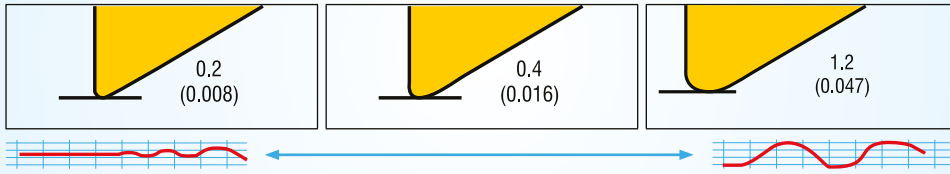

D İşleme derinliği (ap) radyüsten daha büyük olmalıdır.

Machining depth (ap) should be larger than the nose radius.

Die Bearbeitungstiefe (ap) sollte größer als der Schneideckenradius sein.

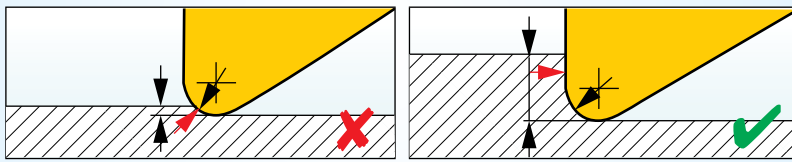

E Kesme kuvvetlerini azaltmak için daha pozitif geometriye sahip bir kesici uç kullanın:

Use an insert with an overall positive geometry to reduce the cutting forces:

Verwenden Sie eine Wendeschneidplatte mit insgesamt positiver Geometrie, um die Schneidkräfte zu reduzieren:

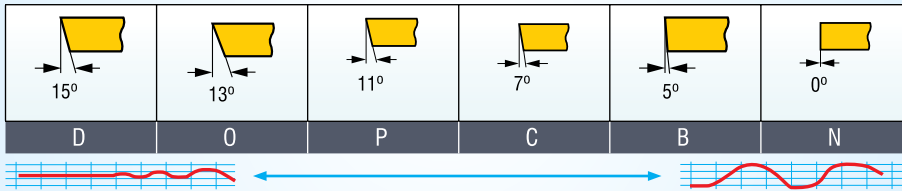

F Pozitif bir üst eğim geometrisi seçin:

Choose a positive top rake geometry:

Benutzen Sie einen positiven, oberen Spanwinkel:

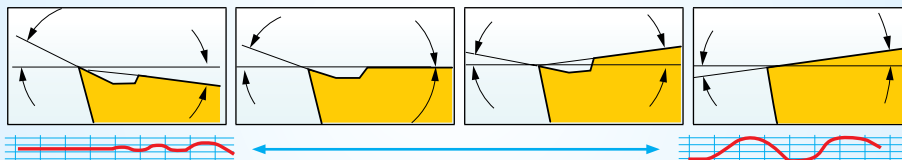

G For-dampened-straight-adaptor:

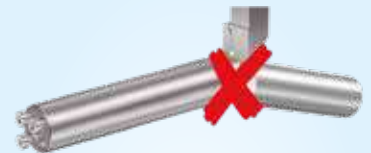

L, kesildikten sonra min uzunluk
L, min length after cut off
L, min Länge nach dem Abschneiden

Ø	Kısa Tasarım Short Design Kurzes Design 4-7x Ø (mm)	Uzun Tasarım Long Design Langes Design 7-10x Ø (mm)
16	100	155
20	125	200
25	155	255
32	190	320
40	240	410
50	305	520
60	380	630



*konusulan
the spoken kalite...
quality...*

DİŞ AÇMA

DİŞ AÇMA TAKIMLARI
THREADING TOOLHOLDERS
GEWINDE DREHHALTER



DIŞ ÇAP DIŞ AÇMA KATERLERİ
EXTERNAL THREADING TOOLHOLDERS
INNEN-GEWINDEDREHHALTER

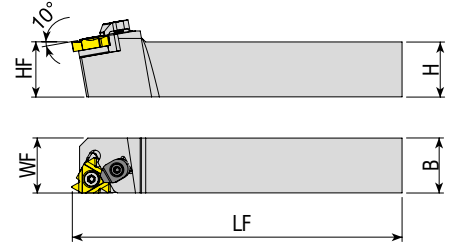
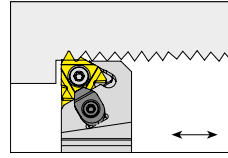

Takım Kodu Ordering Code Bestell-Bezeichnung	Stok Stock Lager		Takım Ölçüleri (mm) Dimension (mm) Abmessung (mm)				Kesici Uç Insert Wendeschneidplatte	Yedek Parçaları / Spare Parts / Ersatzteile					
	R	L	HF=H	B	LF	WF		Sıkma Vidası Screw Schraube	Altlık Shim Unterlage	Altlık Vidası Shim Screw Schraube für Unterlage	Baskı Parçası Wedge Clamp Spannpratze	Baskı Vidası Clamp Screw Klemmschraube	Tork Anahtar Torx Key Torx-Schlüssel
SER/L 2020 H11	●	●	20	20	100	20							
							11 ER/EL	4008-M2.5x6	-	-	-	-	80-T08

DELİK İÇİ DIŞ AÇMA KATERLERİ
INTERNAL THREADING TOOLHOLDERS
INNEN-GEWINDEDREHHALTER

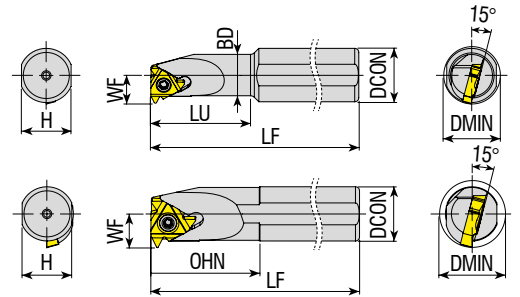
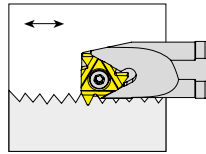

Takım Kodu Ordering Code Bestell-Bezeichnung	Stok Stock Lager		Takım Ölçüleri (mm) Dimension (mm) Abmessung (mm)						Kesici Uç Insert Wendeschneidplatte	Yedek Parçaları / Spare Parts / Ersatzteile					
	R	L	DCON	BD	LF	LU=OHN	WF	DMIN		Sıkma Vidası Screw Schraube	Altlık Shim Unterlage	Altlık Vidası Shim Screw Schraube für Unterlage	Baskı Parçası Wedge Clamp Spannpratze	Baskı Vidası Clamp Screw Klemmschraube	Tork Anahtar Torx Key Torx-Schlüssel
SIR/L S16X05H 06	○	●	16	05	100	15	4.3	6.4							
									06 IR/L	3006-M2X3.6	-	-	-	-	80-T06

R: Sağ / Right / Rechts L: Sol/Left/Links ● Stokta / In Stock / Auf Lager ○ Stokta Yok / Non Stock Item / Kein Lagerartikel, Lieferzeit auf Anfrage
Takımlar standart 1.5° helis açılı olarak üretilir. / The tools have a built in 1.5° helix angle. / GEWINDE-DREHHALTER werden mit Einstellwinkel 1.5° hergestellt
UYARI / WARNING / ACHTUNG: Sayfa 131'deki B ve D figürleri uygulanamaz. / The operation for B and D on page 131 can not be applied. / S.131: für Abbildung B und D: nicht verwenden

Sipariş Örneği/Ordering Example/Bestellbeispiel
1 ad./pcs./stück SER 2020 H11



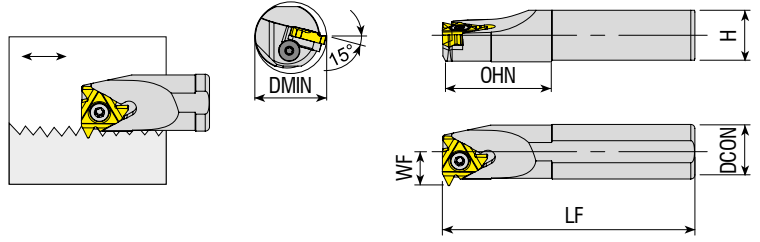

Takım Kodu Ordering Code Bestell-Bezeichnung	Stok Stock Lager		Takım Ölçüleri (mm) Dimension (mm) Abmessung (mm)					Kesici Uç Insert Wendeschneidplatte	Yedek Parçaları / Spare Parts / Ersatzteile						
	R	L	DCON	WF	LF	OHN	WF		DMIN	Sıkma Vidası Screw Schraube	Sol Altılık Left Shim U-Platte für WSP links	Sağ Altılık Right Shim U-Platte für WSP rechts	Altılık Vidası Shim Screw Schraube für Unterlage	Altılık Vidası Pulu Shim Screw Ring Schraube für Unterlagering	Tork Anahtar Torx Key Torx-Schlüssel
TIR/L A25R 16	○	●	25	25	200	50	16.2	29	16 IR/L	1710-U5-40x12.2	ATS-16E	ATS-16I	AAV-11-U5-40x4.5	ABPL-03	80-T10
TIR/L A32S 16	○	●	32	32	250	60	19.7	36							
TIR/L A40T 16	○	●	40	40	300	65	23.9	44							

R: Sağ / Right / Rechts L: Sol/Left/Links ● Stokta / In Stock / Auf Lager ○ Stokta Yok / Non Stock Item / Kein Lagerartikel, Lieferzeit auf Anfrage
Takımlar standart 1.5° helis açılı olarak üretilir. / The tools have a built in 1.5° helix angle. / GEWINDE-DREHHALTER werden mit Einstellwinkel 1.5° hergestellt
Sipariş Örneği/Ordering Example/Bestellbeispiel
1 ad./pcs./stück TIR S25R 16

DELİK İÇİ SAĞ YÖNDE VİDA AÇMA
INTERNAL RIGHT HAND THREADING OPERATION
HERSTELLUNG VON INNEN-RECHTSGEWİNDE

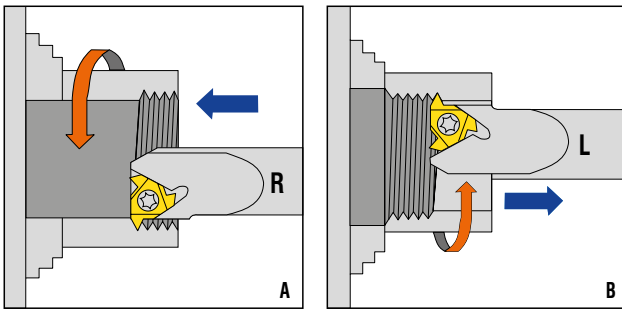

DELİK İÇİ SOL YÖNDE VİDA AÇMA
INTERNAL LEFT HAND THREADING OPERATION
HERSTELLUNG VON INNEN-LINKSGEWİNDE

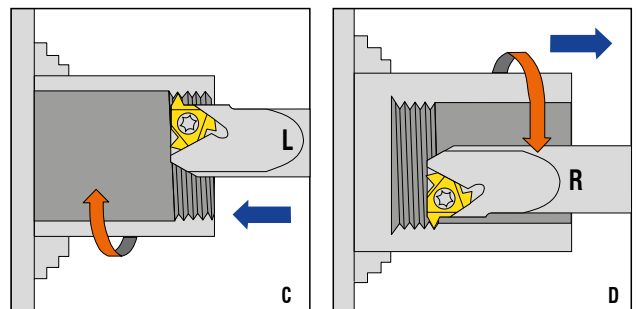

UYARI / WARNING / ACHTUNG

Figür B ve D için; negatif açılı altlık kullanılmalıdır. / For figure B and D; negative shim must be used. / Für Abbildung B und D; negative Unterlage verwenden.
Altıksız katerlerde B ve D figürü uygulanamaz. / B and D figures can not be applied on tools without shim. / Für Abbildung B und D; kann nicht mit Werkzeugen ohne Unterlegplatte erfolgen.



*konusulan
the spoken kalite...
quality...*

KANAL AÇMA

KANAL AÇMA TAKIMLARI
GROOVING TOOLHOLDERS
STECHHALTER





new

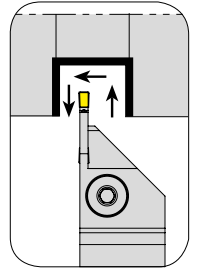
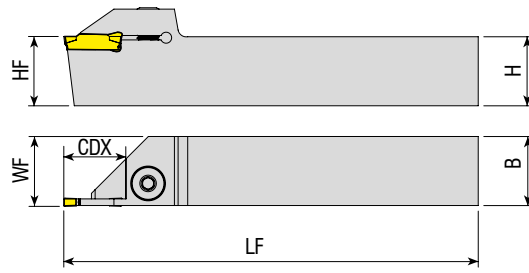

Takım Kodu Ordering Code Bestell-Bezeichnung	Stok Stock Lager		Takım Ölçüleri (mm) Dimension (mm) Abmessung (mm)					Kesici Uç Insert Wendeschneidplatte	Yedek Parçaları / Spare Parts / Ersatzteile		
	R	L	HF=H	B	LF	WF	CDX		Sıkma Vidası Screw Schraube	Pul Stamp Ring	Anahtar Allen Key Innensechskantschlüssel
ADKT-K-R/L-1616-2-T10	●	●	16	16	125	16.3	10				

KRLY - JD Ucuna Uygunur. / Compatiple with KRLY - JD Insert. / Kompatibel mit KRLY - JD Wendeplatten

new

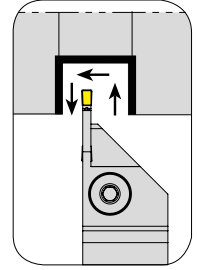
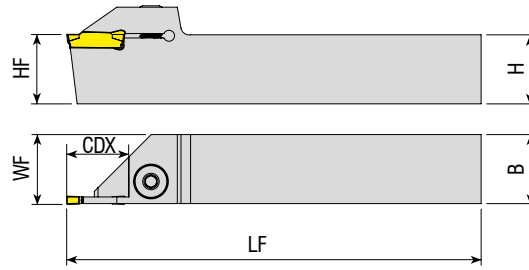

Takım Kodu Ordering Code Bestell-Bezeichnung	Stok Stock Lager		Takım Ölçüleri (mm) Dimension (mm) Abmessung (mm)					Kesici Uç Insert Wendeschneidplatte	Yedek Parçaları / Spare Parts / Ersatzteile		
	R	L	HF=H	B	LF	WF	CDX		Sıkma Vidası Screw Schraube	Pul Stamp Ring	Anahtar Allen Key Innensechskantschlüssel
ADKT-KG-R/L-2525-2-T8	●	●	25	25	150	25.2	8				
ADKT-KG-R/L-2525-3-T10	●	●	25	25	150	25.3	10		2004-M8x1x20	-	AAL-05-4
ADKT-KG-R/L-2525-3-T13	●	●	25	25	150	25.3	13				
ADKT-KG-R/L-2525-4-T10	●	●	25	25	150	20.4	10				
ADKT-KG-R/L-2525-5-T12	●	●	25	25	150	25.5	12				
ADKT-KG-R/L-2525-5-T15	●	●	25	25	150	25.5	15				

R: Sağ / Right / Rechts L: Sol/Left/Links

● Stokta / In Stock / Auf Lager ○ Stokta Yok / Non Stock Item / Kein Lagerartikel, Lieferzeit auf Anfrage
KRLY Ucuna Uygunur. / Compatiple with KRLY Insert. / Kompatibel mit KRLY Wendeplatten

Sipariş Örneği/Ordering Example/Bestellbeispiel
1 ad./pcs./stück ADKT-K-R-1616-2-T10

new

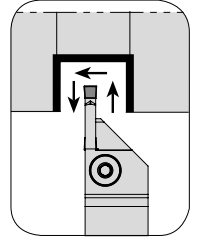
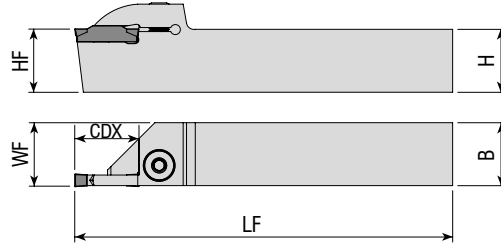

Takım Kodu Ordering Code Bestell-Bezeichnung	Stok Stock Lager		Takım Ölçüleri (mm) Dimension (mm) Abmessung (mm)				Kesici Uç Insert Wendeschneidplatte	Yedek Parçaları / Spare Parts / Ersatzteile			
	R	L	HF=H	B	LF	WF		CDX	Sıkma Vidası Screw Schraube	Pul Stamp Ring	Anahtar Allen Key Innerschloßschlüssel
ADKT-ZCC2-R/L-2020-2-T7	●	●	20	20	125	20.2	7				

ZCC Ucuna Uygunur. / Compatible with ZCC Insert. / Kompatibel mit ZCC Wendeplatten.

new

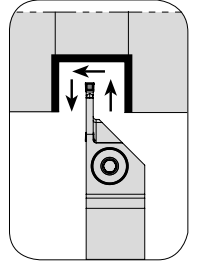
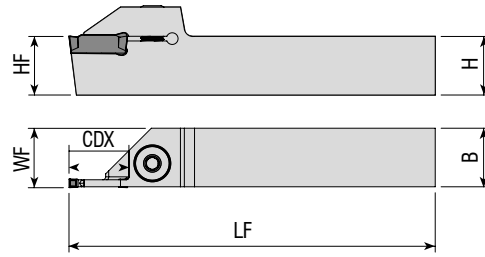

Takım Kodu Ordering Code Bestell-Bezeichnung	Stok Stock Lager		Takım Ölçüleri (mm) Dimension (mm) Abmessung (mm)				Kesici Uç Insert Wendeschneidplatte	Yedek Parçaları / Spare Parts / Ersatzteile			
	R	L	HF=H	B	LF	WF		CDX	Sıkma Vidası Screw Schraube	Pul Stamp Ring	Anahtar Allen Key Innerschloßschlüssel
ADKT-I-R/L-2020-3-T12	●	●	20	20	125	20.3	12				
ADKT-I-R/L-2525-3-T12	●	●	25	25	150	25.3	12				
AADKT-I-R/L-2525-4-T12	●	●	25	25	150	25.4	12		2004-M8x1x20	-	AAL-05-4
ADKT-I-R/L-2525-5-T12	●	●	25	25	150	25.4	12				
ADKT-I-R/L-2525-5-T25	●	●	25	25	150	25.3	12		2004-M8x1x20	-	AAL-05-4
ADKT-IG-R/L-2020-3-T12	●	●	20	20	125	20.3	12				
ADKT-IG-R/L-2525-3-T12	●	●	25	25	150	25.3	12		2004-M8x1x20	-	AAL-05-4
ADKT-IGI-R/L-2525-3-T9	●	●	25	25	150	25.3	9				

R: Sağ / Right / Rechts L: Sol/Left/Links





● Stokta / In Stock / Auf Lager ○ Stokta Yok / Non Stock Item / Kein Lagerartikel, Lieferzeit auf Anfrage
ISCR Ucuna Uygunur. / Compatible with ISCR Insert. / Kompatibel mit ISCR Wendeplatten.

Sipariş Örneği/Ordering Example/Bestellbeispiel
1 ad./pcs./stück ADKT-ZCC-R-2020-2-T7

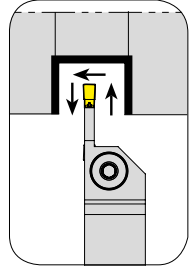
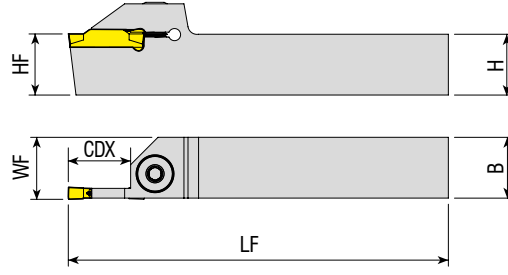

new



Takım Kodu Ordering Code Bestell-Bezeichnung	Stok Stock Lager		Takım Ölçüleri (mm) Dimension (mm) Abmessung (mm)					Kesici Uç Insert Wendeschneidplatte	Yedek Parçaları / Spare Parts / Ersatzteile			
	R	L	HF=H	B	LF	WF	CDX		Sıkma Vidası Screw Schraube	Pul Stamp Ring	Anahtar Allen Key Innensechskantschlüssel	
ADKT-123-R/L-2525-2-T8	●	●	25	25	150	25.2	8					
ADKT-123-R/L-1616-3-T10	●	●	16	16	125	16.3	10					
ADKT-123-R/L-2020-3-T10	●	●	20	20	125	20.3	10					
ADKT-123-R/L-2020-3-T15	●	●	20	20	125	20.3	15	123 - 3	2004-M8x1x20	-	AAL-05-4	
ADKT-123-R/L-2525-3-T10	●	●	25	25	150	25.3	10					
ADKT-123-R/L-2525-3-T15	●	●	25	25	150	25.3	15					
ADKT-123-R/L-2525-4-T13	●	●	25	25	150	20.4	13	123 - 4				

R: Sağ / Right / Rechts L: Sol/Left/Links

● Stokta / In Stock / Auf Lager ○ Stokta Yok / Non Stock Item / Kein Lagerartikel, Lieferzeit auf Anfrage
SNDVK Ucuna Uygunudur. / Compatible with SNDVK Insert. / Kompatibel mit SNDVK Wendepplatten.

Sipariş Örneği/Ordering Example/Bestellbeispiel
1 ad./pcs./stück ADKT-123-R-1212-1.5-R15

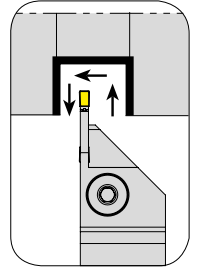
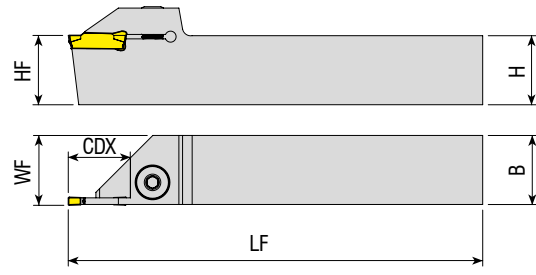

Takım Kodu Ordering Code Bestell-Bezeichnung	Stok Stock Lager		Takım Ölçüleri (mm) Dimension (mm) Abmessung (mm)				Kesici Uç Insert Wendeschneidplatte	Yedek Parçaları / Spare Parts / Ersatzteile			
	R	L	HF=H	B	LF	WF		CDX	Sıkma Vidası Screw Schraube	Pul Stamp Ring	Anahtar Allen Key Inmenschlüssel
ADKT-TD-R/L-1616-2-T8	●	●	16	16	125	16.2	8	TD - 2	AKV-02-M6x22	ABPL-01	AAL-03-3
ADKT-TD-R/L-2525-2-T8	●	●	25	25	150	25.2	8				
ADKT-TD-R/L-2020-2-T17	●	○	20	20	125	20.2	17	TD - 3	2004-M8x1x20	-	AAL-05-4
ADKT-TD-R/L-2020-3-T12	●	●	20	20	125	20.4	12				
ADKT-TD-R/L-2525-3-T12	●	●	25	25	150	25.4	12	TD - 4	2004-M8x1x20	-	AAL-05-4
ADKT-TD-R/L-2525-4-T10	●	●	25	25	150	25.5	10				
ADKT-TD-R/L-2525-4-T15	●	●	25	25	150	25.5	15	TD - 4	2004-M8x1x20	-	AAL-05-4
ADKT-TD-R/L-2525-4-T25	●	○	25	25	150	25.5	25				

TGTC Ucuna Uygundur. / Compatible with TGTC Insert. / Kompatibel mit TGTC Wendeplatten.

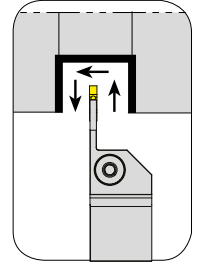
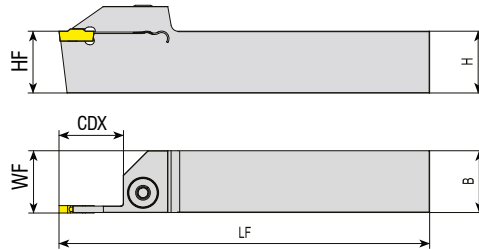

Takım Kodu Ordering Code Bestell-Bezeichnung	Stok Stock Lager		Takım Ölçüleri (mm) Dimension (mm) Abmessung (mm)				Kesici Uç Insert Wendeschneidplatte	Yedek Parçaları / Spare Parts / Ersatzteile			
	R	L	HF=H	B	LF	WF		CDX	Sıkma Vidası Screw Schraube	Pul Stamp Ring	Anahtar Allen Key Inmenschlüssel
ADKT-RD-R/L-1616-2-T17	●	○	16	16	125	16.2	17	RD - 2	AKV-02-M6x22	ABPL-01	AAL-03-3
ADKT-RD-R/L-2020-2-T17	●	○	20	20	125	20.2	17				
ADKT-RD-R/L-2525-2-T17	●	●	25	25	150	25.2	17	RD - 3	2004-M8x1x20	-	AAL-05-4
ADKT-RD-R/L-1616-3-T20	●	○	16	16	125	16.3	20				
ADKT-RD-R/L-2020-3-T25	●	○	20	20	125	20.3	25	RD - 4	2004-M8x1x20	-	AAL-05-4
ADKT-RD-R/L-2525-3-T25	●	●	25	25	150	25.3	25				
ADKT-RD-R/L-2020-4-T30	●	○	20	20	125	20.5	30	RD - 4	2004-M8x1x20	-	AAL-05-4
ADKT-RD-R/L-2525-4-T30	●	●	25	25	150	25.5	30				

R: Sağ / Right / Rechts L: Sol/Left/Links

● Stokta / In Stock / Auf Lager ○ Stokta Yok / Non Stock Item / Kein Lagerartikel, Lieferzeit auf Anfrage
TGTC Ucuna Uygundur. / Compatible with TGTC Insert. / Kompatibel mit TGTC Wendeplatten.

Sipariş Örneği/Ordering Example/Bestellbeispiel
1 ad./pcs./stück ADKT-RD-R-1616-2-T17

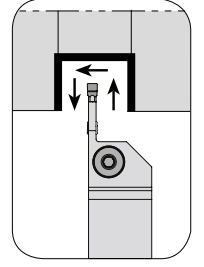
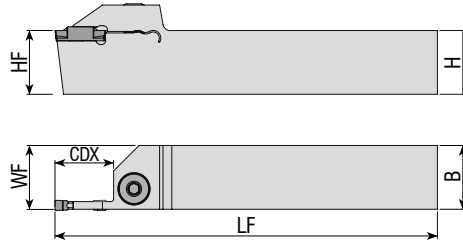

Takım Kodu
Ordering Code
Bestell-Bezeichnung

Stok
Stock
Lager

Takım Ölçüleri (mm)
Dimension (mm)
Abmessung (mm)

Kesici Uç
Insert
Wendeschneidplatte

Yedek Parçaları / Spare Parts / Ersatzteile

Sıkma Vidası
Screw
Schraube

Pul
Stamp
Ring

Anahtar
Allen Key
Innerschlüssel

R

L

HF=H

B

LF

WF

CDX



ADKT-TG-R/L-1616-2-R17	●	○	16	16	125	16.2	17	DGM2-020	AKV-02-M6x22	ABPL-01	AAL-03-3
ADKT-TG-R/L-2020-2-R8	●	○	20	20	125	20.2	8				
ADKT-TG-R/L-2020-2-R12	●	○	20	20	125	20.2	12				
ADKT-TG-R/L-2020-2-R17	●	○	20	20	125	20.2	17				
ADKT-TG-R/L-2525-2-R12	●	○	25	25	150	25.2	12				
ADKT-TG-R/L-2525-2-R17	●	○	25	25	150	25.2	17				
ADKT-TG-R/L-1616-3-T20	●	○	16	16	125	16.3	20	DGM3-020	2004-M8x1x20	-	AAL-05-4
ADKT-TG-R/L-2020-3-T12	●	○	20	20	125	20.3	12				
ADKT-TG-R/L-2020-3-T20	●	○	20	20	125	20.3	20				
ADKT-TG-R/L-2525-3-T9	●	○	25	25	150	25.3	9				
ADKT-TG-R/L-2525-3-T20	●	○	25	25	150	25.3	20				
ADKT-TG-R/L-2525-3-R25	●	○	25	25	150	25.3	25				
ADKT-TG-R/L-2525-4-T15	●	○	25	25	150	25.5	15	DGM4-030			
ADKT-TG-R/L-2525-4-T20	●	○	25	25	150	25.5	20				
ADKT-TG-R/L-2525-4-T25	●	○	25	25	150	25.5	25				
ADKT-TG-R/L-2525-5-T12	●	○	25	25	150	25.5	12	DGM5-030			
ADKT-TG-R/L-2525-5-T25	●	○	25	25	150	25.5	25				
ADKT-TG-R/L-2525-5-T32	●	○	25	25	150	25.5	32				

R: Sağ / Right / Rechts L: Sol/Left/Links

● Stokta / In Stock / Auf Lager ○ Stokta Yok / Non Stock Item / Kein Lagerartikel, Lieferzeit auf Anfrage
TNGLY Ucuna Uygunudur. / Compatible with TNGLY Insert. / Kompatibel mit TNGLY Wendeplatten.

Sipariş Örneği/Ordering Example/Bestellbeispiel
1 ad./pcs./stück ADKT-TG-R-1616-2-R17

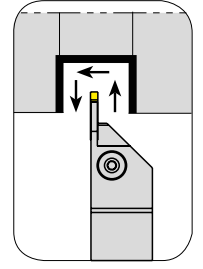
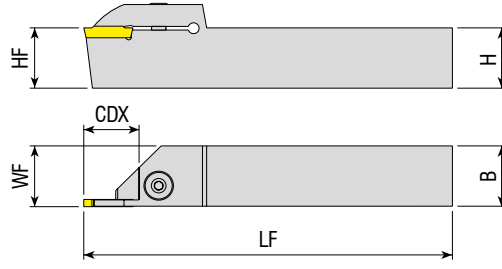

Takım Kodu Ordering Code Bestell-Bezeichnung	Stok Stock Lager		Takım Ölçüleri (mm) Dimension (mm) Abmessung (mm)				Kesici Uç Insert Wendeschneidplatte	Yedek Parçaları / Spare Parts / Ersatzteile			
	R	L	HF=H	B	LF	WF		CDX	Sıkma Vidası Screw Schraube	Pul Stamp Ring	Anahtar Allen Key Innensechskantschlüssel
ADKT-WGX24-R/L-2525-3-T12	●	●	25	25	150	25.4	12				

WLTR Ucuna Uygunur. / Compatible with WLTR Insert. / Kompatibel mit WLTR Wendeplatten.

DIŞ ÇAP KANAL AÇMA İSVİÇRE TİPİ KAYAR OTOMAT MAKİNA TAKIMLARI
EXTERNAL GROOVING TOOLHOLDERS FOR SWISS TYPE SLIDING AUTOMATIC LATHES
WERKZEUGE ZUR STECHBEARBEITUNG AUF LANGDREHAUTOMATEN

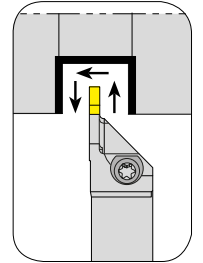
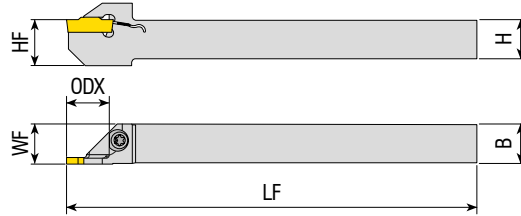

Takım Kodu Ordering Code Bestell-Bezeichnung	Stok Stock Lager		Takım Ölçüleri (mm) Dimension (mm) Abmessung (mm)				Kesici Uç Insert Wendeschneidplatte	Yedek Parçaları / Spare Parts / Ersatzteile			
	R	L	HF=H	B	LF	WF		CDX	Sıkma Vidası Screw Schraube	Pul Stamp Ring	Tork Anahtar Torx Key Torx-Schlüssel
ADKT-RD-R/L-1212-2-T12-K-S	●	●	12	12	125	12.2	12				
ADKT-RD-R/L-1616-2-T17-K-S	○	●	16	16	125	16.2	17	RD - 2			
ADKT-RD-R/L-1212-3-T12-K-S	●	●	12	12	125	12.2	12	RD - 3			

R: Sağ / Right / Rechts L: Sol/Left/Links

● Stokta / In Stock / Auf Lager ○ Stokta Yok / Non Stock Item / Kein Lagerartikel, Lieferzeit auf Anfrage
TGTC Ucuna Uygunur. / Compatible with TGTC Insert. / Kompatibel mit TGTC Wendeplatten.

Sipariş Örneği/Ordering Example/Bestellbeispiel
1 ad./pcs./stück ADKT-WGX24-R-2525-3-T12



new

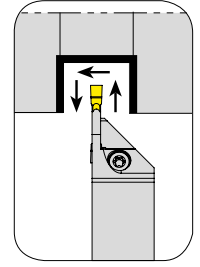
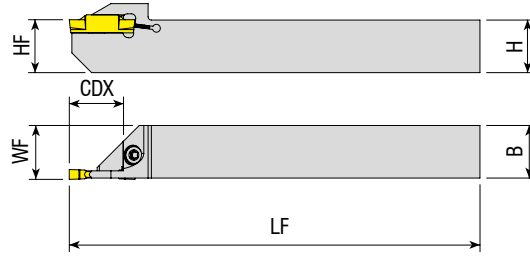

Takım Kodu Ordering Code Bestell-Bezeichnung	Stok Stock Lager		Takım Ölçüleri (mm) Dimension (mm) Abmessung (mm)				Kesici Uç Insert Wendeschneidplatte	Yedek Parçaları / Spare Parts / Ersatzteile			
	R	L	HF=H	B	LF	WF		CDX	Sıkma Vidası Screw Schraube	Pul Stamp Ring	Tork Anahtar Torx Key Torx-Schlüssel
ADKT-TG-R/L-1212-2-R12-K-S	●	○	12	12	125	12.2	12	DGM2-020	4015-M4x11	-	80-T15
ADKT-TG-R/L-1212-3-R12-K-S	●	○	12	12	125	12.3	12	DGM3-020			

TNGLY Ucuna Uygunur. / Compatible with TNGLY Insert. / Kompatibel mit TNGLY Wendepplatten.

DIŞ ÇAP ALIN KANAL AÇMA TAKIMLARI
FACE EXTERNAL GROOVING TOOLHOLDERS
AXIAL-STECHHALTER



new

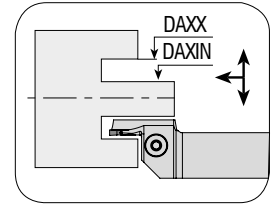
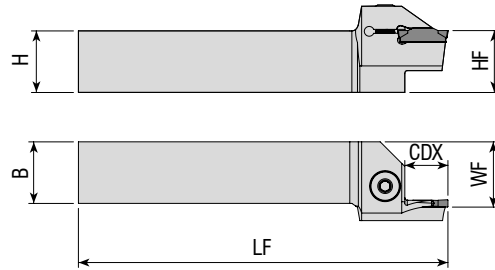

Takım Kodu Ordering Code Bestell-Bezeichnung	Stok Stock Lager		Takım Ölçüleri (mm) Dimension (mm) Abmessung (mm)							Kesici Uç Insert Wendeschneidplatte	Yedek Parçaları / Spare Parts / Ersatzteile		
	R	L	HF=H	B	LF	WF	CDX	DAXIN	DAXX		Sıkma Vidası Screw Schraube	Pul Stamp Ring	Anahtar Allen Key Innerschlüssel
AAKT-ZCC2-R/L-2525-70-110-3-T15	●	○	25	25	150	26.5	15	70	110	Z.FD - 3	2004-M8x1x20	-	AAL-05-4

R: Sağ / Right / Rechts L: Sol/Left/Links

● Stokta / In Stock / Auf Lager ○ Stokta Yok / Non Stock Item / Kein Lagerartikel, Lieferzeit auf Anfrage
ZCC Ucuna Uygunur. / Compatible with ZCC Insert. / Kompatibel mit ZCC Wendepplatten.

Sipariş Örneği/Ordering Example/Bestellbeispiel
1 ad./pcs./stück ADKT-TG-R-1212-2-R12-K-S

*konusulan
the spoken kalite...
quality...*

KANAL AÇMA

İÇTEN SOĞUTMA KANALLI KANAL AÇMA TAKIMLARI
GROOVING TOOLHOLDERS WITH COOLANT TOOLS
STECHEHALTER MIT KÜHLWERKZEUG



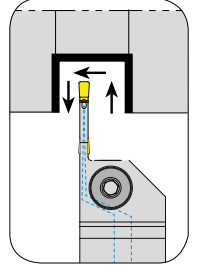
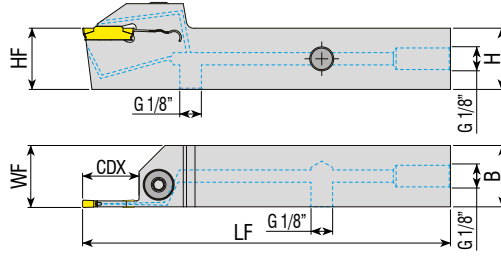

Takım Kodu Ordering Code Bestell-Bezeichnung	Stok Stock Lager		Takım Ölçüleri (mm) Dimension (mm) Abmessung (mm)				Kesici Uç Insert Wendeschneidplatte	Yedek Parçaları / Spare Parts / Ersatzteile			
	R	L	HF=H	B	LF	WF		CDX	Sıkma Vidası Screw Schraube	Pul Stamp Ring	Anahtar Allen Key Innensechskantschlüssel
ADKT-K-R/L-2020-3-T20-H	●	●	20	20	125	20.4	20	MGM. - 3	2004-M8x1x20	-	AAL-05-4
ADKT-K-R/L-2525-3-T22-H	●	●	25	25	150	25.4	22				
ADKT-K-R/L-2020-4-T20-H	●	●	20	20	125	20.4	20	MGM. - 4	2004-M8x1x20	-	AAL-05-4
ADKT-K-R/L-2525-4-T22-H	●	●	25	25	150	25.4	22				
ADKT-K-R/L-2525-5-T25-H	●	●	25	25	150	25.5	25	MGM. - 5			

KRLY Ucuna Uygundur. / Compatible with KRLY Insert. / Kompatibel mit KRLY Wendeplatten.

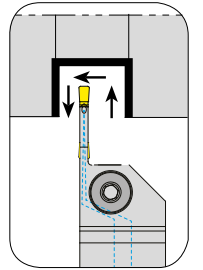
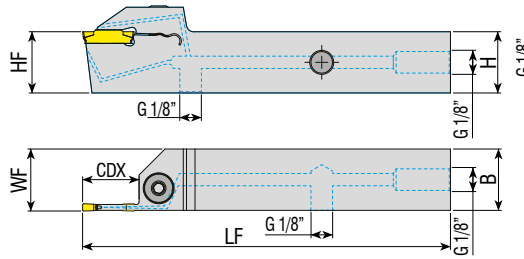

Takım Kodu Ordering Code Bestell-Bezeichnung	Stok Stock Lager		Takım Ölçüleri (mm) Dimension (mm) Abmessung (mm)				Kesici Uç Insert Wendeschneidplatte	Yedek Parçaları / Spare Parts / Ersatzteile			
	R	L	HF=H	B	LF	WF		CDX	Sıkma Vidası Screw Schraube	Pul Stamp Ring	Anahtar Allen Key Innensechskantschlüssel
ADKT-TD-R/L-2020-3-T30-H	●	●	20	20	125	20.5	30	TD. - 3	2004-M8x1x20	-	AAL-05-4

R: Sağ / Right / Rechts L: Sol/Left/Links
● Stokta / In Stock / Auf Lager ○ Stokta Yok / Non Stock Item / Kein Lagerartikel, Lieferzeit auf Anfrage
TGTC Ucuna Uygundur. / Compatible with TGTC Insert. / Kompatibel mit TGTC Wendeplatten.

Sipariş Örneği/Ordering Example/Bestellbeispiel
1 ad./pcs./stück ADKT-K-R-2020-3-T20-H

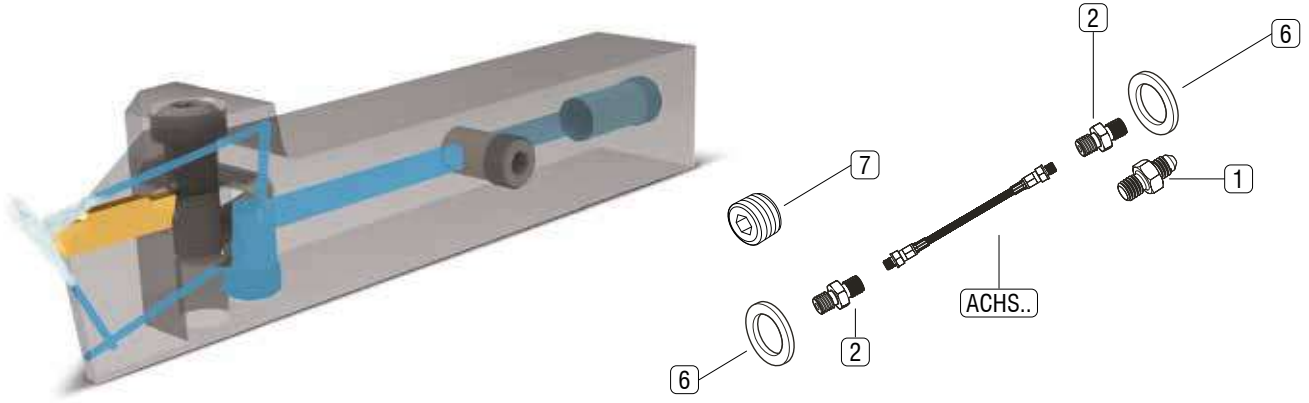

Not: İçten soğutmalı tüm torna katerlerinde kullanılabilen 3 tip soğutma hortum setleri tasarlanmıştır. Takımların kullanılmasından önce, kullanılmayan bağlantıların set içindeki vida ile kapatılarak sızdırmazlığın sağlanmasına dikkat edilmelidir. Torna katerlerine yönelik soğutma hortum setleri, ACHS... 10 bar ile maksimum 275 bar basınç aralığında kullanılabilir.

Note: 3 types of cooling hose sets are designed that can be used in all internally cooled lathes. Before using the tools, care should be taken to ensure that the unused connections are closed with the screw in the set and that sealing is ensured. Cooling hose sets for lathe tools can be used in the pressure range of ACHS ... 10 bar to max 275 bar.

Notiz: Es wurden 3 Arten von Kühlschlauch-Sets entwickelt, die in allen intern gekühlten Drehmaschinen verwendet werden können. Vor der Verwendung der Werkzeuge sollte darauf geachtet werden, dass die nicht verwendeten Verbindungen mit der Schraube im Satz geschlossen werden und die Abdichtung gewährleistet ist. Kühlschlauchsätze für Drehmaschinen können im Druckbereich von ACHS ... 10 bar bis max. 275 bar eingesetzt werden.

Set içindeki Parçalar Parts In The Set Teile im Set				Uzunluk / Length Code / Länge Einstellen: 250		
				Set Kodu: Set Code: Code Einstellen: ACHS-1-250	Set Kodu: Set Code: Code Einstellen: ACHS-2-250	Set Kodu: Set Code: Code Einstellen: ACHS-3-250
Resim Picture Bild	Takım Kodu Set Code Code Einstellen	Ürün Açıklaması Product Description Artikelbeschreibung				
1	AMP-01	M10 Bağlantı Elemanı M10 Fastener M10 Verschluss	1x	-	-	
2	AMP-02	G 1/8" Çift Bağlantı Elemanı G 1/8" Double Fastener G 1/8" Doppelverschluss	2x	1x	-	
3	AMP-03	G 1/8" Açılı Bağlantısı G 1/8" Angle Connection G 1/8" Winkelverbindung	-	1x	2x	
4	AMP-04	M10" Açılı Bağlantısı M10" Angle Connection M10" Winkelverbindung	-	1x	1x	
5	AMP-05	G1/4"-G1/8" Kısılma Parçası G1 / 4"-G1/8" Capillary Piece G1 / 4"-G1/8" Kapillarstück	-	1x	1x	
6	AG-01	Bakır Conta Copper Gasket Kupferdichtung	2x	3x	4x	
7	2705-G1/8-5.5	G1/8" Sızdırmaz Civata G1/8" Sealing Bolt G1/8" Dichtungsschraube	1x	1x	1x	
8	AH-1-250	Hortum Hose Schlauch	1x	-	-	
9	AH-2-250	Hortum Hose Schlauch	-	1x	-	
10	AH-3-250	Hortum Hose Schlauch	-	-	1x	



*konusulan
the spoken kalite...
quality...*

U-DRILL

TAKMA UÇLU MATKAPLAR
U-DRILL SYSTEM
VOLLBOHRER



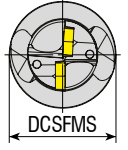
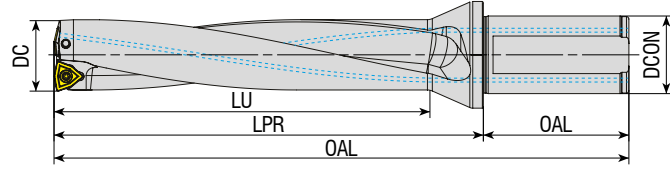

Delme Derinliği = 5xÇap
Drilling Depth = 5xDiameter
Bohrtiefe = 5xDurchmesser

Takım Kodu
Ordering Code
Bestell-Bezeichnung

Stok Stock Lager	Takım Ölçüleri (mm) Dimension (mm) Abmessung (mm)								Maks. Ofset (radyal) Max. Offset (radial) Max. Versatz (radial)		Kesici Uç Insert Wendeschneidplatte	Yedek Parçaları / Spare Parts / Ersatzteile	
	DC	DCON	DCSFMS	OAL	LU	LPR	LS	X _{max}	DC _{max}	Sıkma Vidası Screw Schraube		Tork Anahtar Torx Key Torx-Schlüssel	
●	20	25	34	178	100	122	56	1.4	22.8	WCM. 040208	3008-M2.5x6	80-T08	
●	21	25	34	183	105	127	56	1	23				
●	22	25	34	188	110	132	56	0.9	23.8				
●	23	25	34	193	115	137	56	0.8	24.6				
●	24	25	34	198	120	142	56	1.4	26.8	WCM. 050308	3008-M3x8	80-T10	
●	25	25	34	203	125	147	56	1.4	27.8				
●	26	25	34	208	130	152	56	1.4	28.8				
●	27	25	34	213	135	157	56	1.4	29.8				
●	28	25	34	218	140	162	56	1.4	30.8				
●	29	25	34	223	145	167	56	1.4	31.8				
●	30	32	44	237	150	177	60	2.4	34.8	WCM. 06T308	3010-M3.5x9	80-T10	
●	31	32	44	242	155	182	60	2.3	35.6				
●	32	32	44	247	160	187	60	2.1	36.2				
●	33	32	44	252	165	192	60	1.9	36.8				
●	34	32	44	257	170	197	60	1.9	37.8				
●	35	32	44	262	175	202	60	1.8	38.6				
●	37	32	44	272	185	212	60	1.6	40.2				
●	38	32	44	277	190	217	60	1.5	41				
●	46	40	54	332	230	262	70	3	52	WCM. 080412	4015-M4x11	80-T15	

R: Sağ / Right / Rechts L: Sol/Left/Links

● Stokta / In Stock / Auf Lager ○ Stokta Yok / Non Stock Item / Kein Lagerartikel, Lieferzeit auf Anfrage

ISO Ucuna Uygundur. / Compatible with ISO Insert. / Kompatibel mit ISO Wendeplatten.

Sipariş Örneği/Ordering Example/Bestellbeispiel

1 ad./pcs./stück ATUM 20XD5 WCM. 040208

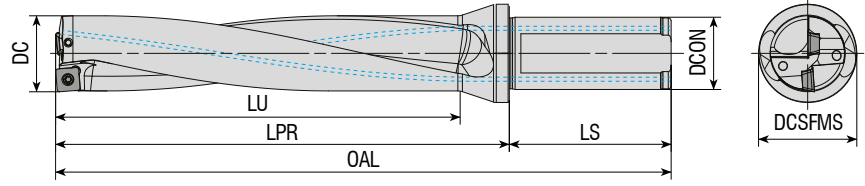

Delme Derinliği = 5xÇap
Drilling Depth = 5xDiameter
Bohrtiefe = 5xDurchmesser

Takım Kodu
Ordering Code
Bestell-Bezeichnung

Stok Stock Lager	Takım Ölçüleri (mm) Dimension (mm) Abmessung (mm)								Maks. Ofset (radyal) Max. Offset (radial) Max. Versatz (radial)		Kesici Uç Insert Wendeschneidplatte	Yedek Parçaları / Spare Parts / Ersatzteile		
	DC	DCON	DCSFMS	OAL	LU	LPR	LS	X _{max}	DC _{max}	Sıkma Vidası Screw Schraube		Tork Anahtar Torx Key Torx-Schlüssel		
●	14	20	25	142	70	92	50	0.5	15.00	SP. 050204	3006-M2x4	80-T06		
●	16	25	34	158	80	102	56	0.5	17.00					
●	17	25	34	163	85	107	56	0.5	18.00					
●	18	25	34	168	90	112	56	0.5	19.00					
●	19	25	34	173	95	117	56	0.25	19.50					
●	20	25	34	178	100	122	56	0	20.00					
●	21	25	34	183	105	127	56	0	21.00					
●	22	25	34	188	110	132	56	0.5	23.00	SP. 07T308	3008-M2.5x6	80-T08		
●	22	32	44	197	110	137	60	0.5	23.00					
●	23	25	34	193	115	137	56	0.5	24.00					
●	23	32	44	202	115	142	60	0.5	24.00					
●	24	32	44	207	120	147	60	0.5	25.00					
●	25	25	34	203	125	147	56	0.25	25.50					
●	25	32	44	212	125	152	60	0.25	25.50					
●	26	25	34	208	130	152	56	0	26.00					
●	26	32	44	217	130	157	60	0	26.00					
●	27	25	34	213	135	157	56	0	27.00					
●	27	32	44	222	135	162	60	0	27.00					
●	28	32	44	227	140	167	60	0.5	29.00	SP. 090408	4015-M3.5x9	80-T15		
●	29	32	44	232	145	172	60	0.5	30.00					
●	30	32	44	237	150	177	60	0.5	31.00					
●	31	32	44	242	155	182	60	0.25	31.50					
●	32	32	44	247	160	187	60	0	32.00					
●	32	32	44	247	160	187	60	0	32.00					
●	33	32	44	252	165	192	60	0	33.00					

R: Sağ / Right / Rechts L: Sol/Left/Links
● Stokta / In Stock / Auf Lager ○ Stokta Yok / Non Stock Item / Kein Lagerartikel, Lieferzeit auf Anfrage
TGTC Ucuna Uygundur. / Compatible with TGTC Insert. / Kompatibel mit TGTC Wendeplatten.

Sipariş Örneği/Ordering Example/Bestellbeispiel
1 ad./pcs./stück ATUM 14XD5 SP. 050204



Delme Derinliği
Drilling Depth
Bohrtiefe
= 3xÇap
= 3xDiameter
= 3xDurchmesser

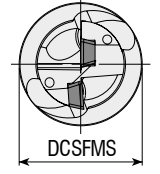
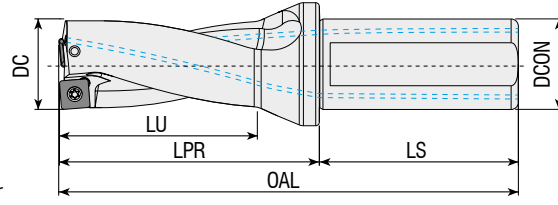

Takım Kodu Ordering Code Bestell-Bezeichnung	Stok Stock Lager	Takım Ölçüleri (mm) Dimension (mm) Abmessung (mm)							Maks. Ofset (radyal) Max. Offset (radial) Max. Versatz (radial)		Kesici Uç Insert Wendeschneidplatte	Yedek Parçaları / Spare Parts / Ersatzteile	
		DC	DCON	DCSFMS	OAL	LU	LPR	LS	X _{max}	DC _{max}		Sıkma Vidası Screw Schraube	Tork Anahtar Torx Key Torx-Schlüssel
ATUM 21XD3 SO.. 070305	●	21	25	34	141	63	85	56	1.75	24.5	SO.. 070305	3008-M2.5x6	80-T08

ISCR Ucuna Uygundur. / Compatible with ISCR Insert. / Kompatibel mit ISCR Wendeplatten.



Delme Derinliği
Drilling Depth
Bohrtiefe
= 2xÇap
= 2xDiameter
= 2xDurchmesser

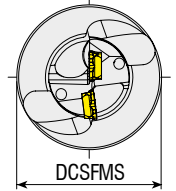
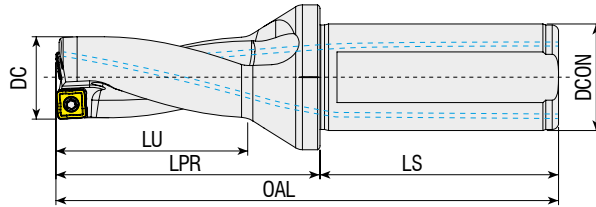

Takım Kodu Ordering Code Bestell-Bezeichnung	Stok Stock Lager	Takım Ölçüleri (mm) Dimension (mm) Abmessung (mm)							Maks. Ofset (radyal) Max. Offset (radial) Max. Versatz (radial)		Kesici Uç Insert Wendeschneidplatte	Yedek Parçaları / Spare Parts / Ersatzteile	
		DC	DCON	DCSFMS	OAL	LU	LPR	LS	X _{max}	DC _{max}		Sıkma Vidası Screw Schraube	Tork Anahtar Torx Key Torx-Schlüssel
ATUM 23XD2 SOMT 08T306	●	23	25	34	124	46	68	56	0.5	24	SOMT 08T306	3008-M2.5x6	80-T08
ATUM 29XD2 SOMT 09T308	●	29	25	34	136	58	80	56	0.5	30	SOMT 09T308	4015-M3.5x9	80-T15
ATUM 47XD2 SOMT 150510	●	47	40	54	196	94	126	70	0.5	48	SOMT 150510	1020-M5x11	80-T20

R: Sağ / Right / Rechts L: Sol/Left/Links

● Stokta / In Stock / Auf Lager ○ Stokta Yok / Non Stock Item / Kein Lagerartikel, Lieferzeit auf Anfrage
TGTC Ucuna Uygundur. / Compatible with TGTC Insert. / Kompatibel mit TGTC Wendeplatten.

Sipariş Örneği/Ordering Example/Bestellbeispiel

1 ad./pcs./stück ATUM 21XD3 SO.. 070305



Delme Derinliği = 5xÇap
Drilling Depth = 5xDiameter
Bohrtiefe = 5xDurchmesser

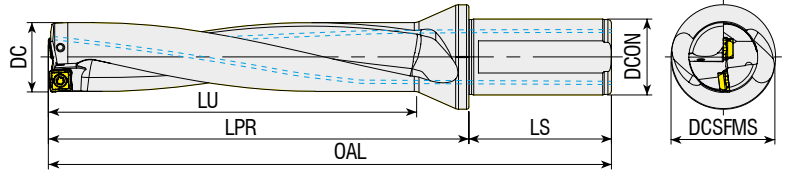

Takım Kodu Ordering Code Bestell-Bezeichnung	Stok Stock Lager	Takım Ölçüleri (mm) Dimension (mm) Abmessung (mm)							Maks. Ofset (radyal) Max. Offset (radial) Max. Versatz (radial)		Kesici Uç Insert Wendeschneidplatte	Yedek Parçaları / Spare Parts / Ersatzteile	
		DC	DCON	DCSFMS	OAL	LU	LPR	LS	X_{max}	DC_{max}		Sıkma Vidası Screw Schraube	Tork Anahtar Torx Key Torx-Schlüssel
ATUM 16.5XD5 SOMT 060204	●	16.5	25	34	158	80	102	56	0.5	17.5	SOMT 060204	3007-M2.2x5	80-T07
ATUM 18.5XD5 SOMT 060204	●	18.5	25	34	168	90	112	56	0.3	19.1			

R: Sağ / Right / Rechts L: Sol/Left/Links

● Stokta / In Stock / Auf Lager ○ Stokta Yok / Non Stock Item / Kein Lagerartikel, Lieferzeit auf Anfrage
TGTC Ucuna Uygunudur. / Compatible with TGTC Insert. / Kompatibel mit TGTC Wendeplatten.



Sipariş Örneği/Ordering Example/Bestellbeispiel
1 ad./pcs./stück ATUM 16.5XD5 SOMT 060204

*konusulan
the spoken kalite...
quality...*

FREZELEME TAKIMLARI
MILLING TOOLS
FRÄSWERKZEUGE

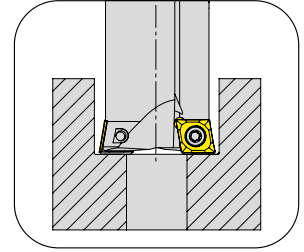
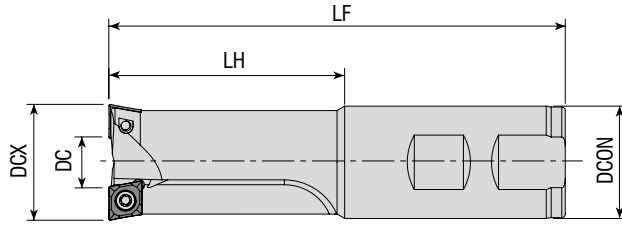

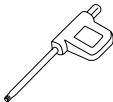

Takım Kodu Ordering Code Bestell-Bezeichnung	Stok Stock Lager	Takım Ölçüleri (mm) Dimension (mm) Abmessung (mm)						Kullanılan Vidalar For Screws Für Schraube	Kesici Uç Insert Wendeschneidplatte	Yedek Parçaları / Spare Parts / Ersatzteile	
		DC	DCX	DCON	LH	LF	Sıkma Vidası Screw Schraube			Tork Anahtar Torx Key Torx-Schlüssel	
ACBM-CC09-D30X12.5-W32-L130-Z02-H	●	12.5	30	32	65	130	-				
								CC.. 09T304	4015-M3.5x9	80-T15	

R: Sağ / Right / Rechts L: Sol/Left/Links

● Stokta / In Stock / Auf Lager ○ Stokta Yok / Non Stock Item / Kein Lagerartikel, Lieferzeit auf Anfrage
 ISO Ucuna Uygunudur. / Compatible with ISO Insert. Kompatibel mit ISO Wendeplatten.

Sipariş Örneği/Ordering Example/Bestellbeispiel
 1 ad./pcs./stück ACBM-CC06-D17X6-W16-L150-Z02



KAPR=90°

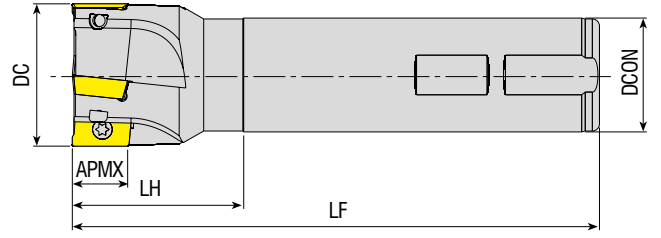

Takım Kodu Ordering Code Bestell-Bezeichnung	Stok Stock Lager	Takım Ölçüleri (mm) Dimension (mm) Abmessung (mm)						Kesici Uç Insert Wendeschneidplatte	Yedek Parçaları / Spare Parts / Ersatzteile	
		DC	ZEPF	DCON	LF	LH	APMX		Sıkma Vidası Screw Schraube	Tork Anahtar Torx Key Torx-Schlüssel
AEM90-AP0903-D12-C16-L080-Z01-H	●	12	1	16	80	30	9	APMT 0903.. KRLY UCUNA UYGUNDUR. FOR KRLY INSERT. Kompatibel mit Wendeschneidplatte KRLY	3008-M2.5x6	
AEM90-AP0903-D16-C16-L090-Z02	●	16	2	16	90	30	9			
AEM90-AP0903-D18-C16-L090-Z02-H	●	18	2	16	90	30	9			
AEM90-AP0903-D20-C20-L110-Z03	●	20	3	20	110	30	9			
AEM90-AP0903-D20-C20-L200-Z02	●	20	2	20	200	100	9			
AEM90-AP0903-D25-C25-L120-Z03	●	25	3	25	120	30	9			
AEM90-AP0903-D25-C25-L200-Z02	●	25	2	25	200	100	9	AP. 1003.. ISO UCUNA UYGUNDUR. FOR ISO INSERT. Kompatibel mit Wendeschneidplatte ISO	3008-M2.5x5	80-T08
AEM90-AP10-D10-C10-L100-Z01	●	10	1	10	100	20	10			
AEM90-AP10-D12-C16-L100-Z01-H	●	12	1	16	100	30	10			
AEM90-AP10-D16-W16-L200-Z02	●	16	2	16	200	100	10			
AEM90-AP10-D21-C20-L200-Z03	●	21	3	20	200	30	10			
AEM90-AP1135Y-D16-C16-L120-Z02-H	●	16	2	16	120	30	9.5			
AEM90-AP1135Y-D17-C16-L150-Z02	●	17	2	16	150	30	9.5	APMT 1135.. YG UCUNA UYGUNDUR. FOR YG INSERT. Kompatibel mit Wendeschneidplatte YG	3008-M2.5x6	
AEM90-AP1135Y-D20-C20-L120-Z02	●	20	2	20	120	30	9.5			
AEM90-AP1135Y-D21-C20-L150-Z03	●	21	3	20	150	30	9.5			
AEM90-AP1135Y-D25-C25-L150-Z04-H	●	25	4	25	150	30	9.5			
AEM90-AP1135Y-D26-C25-L150-Z03	●	26	3	25	150	35	9.5			
AEM90-AP1135Y-D32-W25-L110-Z04	●	32	4	25	110	35	9.5			
AEM90-AP16L-D30-W25-L120-Z03-H	●	30	3	25	120	40	16	AP. 1604.. LMN UCUNA UYGUNDUR. FOR LMN INSERT. AP. 1604.. YG UCUNA UYGUNDUR. FOR YG INSERT. Kompatibel mit Wendeschneidplatte YG	4015-M4x9	80-T15
AEM90-AP16Y-D25-C20-L100-Z02-H	●	25	2	20	100	35	16			
AEM90-AP16Y-D25-C25-L120-Z02	●	25	2	25	120	50	16			
AEM90-AP16Y-D25-C25-L150-Z02	●	25	2	25	150	50	16			
AEM90-AP16Y-D25-C25-L250-Z02	●	25	2	25	250	100	16			

R: Sağ / Right / Rechts L: Sol/Left/Links

● Stokta / In Stock / Auf Lager ○ Stokta Yok / Non Stock Item / Kein Lagerartikel, Lieferzeit auf Anfrage

Sipariş Örneği/Ordering Example/Bestellbeispiel

1 ad./pcs./stück AEM90-AP0903-D12-C16-L080-Z01-H



KAPR=90°

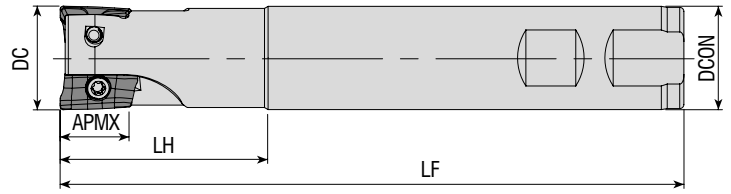

Takım Kodu Ordering Code Bestell-Bezeichnung	Stok Stock Lager	Takım Ölçüleri (mm) Dimension (mm) Abmessung (mm)						Kesici Uç Insert Wendeschneidplatte	Yedek Parçaları / Spare Parts / Ersatzteile	
		DC	ZEFP	DCON	LF	LH	APMX		Sıkma Vidası Screw Schraube	Tork Anahtar Torx Key Torx-Schlüssel
AEM90-BD11T3-D16-C16-L160-Z02-H	●	16	2	16	160	50	10	BDMT 11T3..	3008-M2.5x6	80-T08
AEM90-BD11T3-D20-C20-L170-Z03-H	●	20	3	20	170	50	10			
AEM90-BD11T3-D20-W20-L81-Z03-H	●	20	3	20	81	30	10			
AEM90-BD11T3-D25-C20-L120-Z03-H	●	25	3	20	120	30	10			
AEM90-BD1704-D25-C25-L210-Z03-H	●	25	2	25	210	100	15.7	BDMT 1704..	4015-M4x8	80-T15
AEM90-BD1704-D32-C32-L130-Z03-H	●	32	3	32	130	40	15.7			
AEM90-BD1704-D32-W32-L130-Z03-H	●	32	3	32	130	40	15.7			

KYCR Ucuna Uygunur. / Compatible with KYCR Insert. Kompatibel mit KYCR Wendeplatten.



KAPR=90°

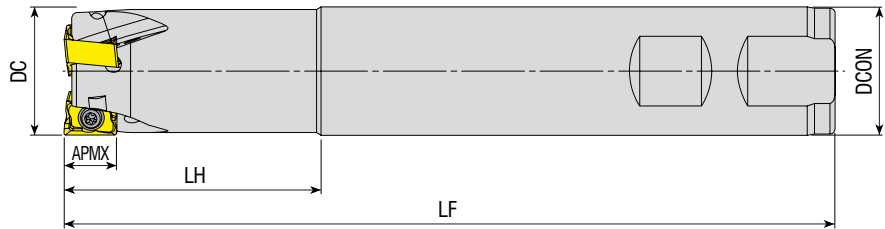

Takım Kodu Ordering Code Bestell-Bezeichnung	Stok Stock Lager	Takım Ölçüleri (mm) Dimension (mm) Abmessung (mm)						Kesici Uç Insert Wendeschneidplatte	Yedek Parçaları / Spare Parts / Ersatzteile	
		DC	ZEFP	DCON	LF	LH	APMX		Sıkma Vidası Screw Schraube	Tork Anahtar Torx Key Torx-Schlüssel
AEM90-LN1006-D16-W16-L120-Z01-H	●	16	1	16	120	30	9	LN.X 1006..	4010-M3x8	80-T10
AEM90-LN1006-D16-W16-L150-Z01	●	16	1	16	150	50	9			
AEM90-LN1006-D18-W16-L120-Z02-H	●	18	2	16	120	30	9			
AEM90-LN1006-D20-W20-L120-Z02-H	●	20	2	20	120	30	9			
AEM90-LN1006-D20-W20-L150-Z02	●	20	2	20	150	50	9			
AEM90-LN1006-D25-W25-L120-Z03-H	●	25	3	25	120	30	9			
AEM90-LN1006-D25-W25-L150-Z03	●	25	3	25	150	50	9			
AEM90-LN1006-D32-W32-L120-Z04-H	●	32	4	32	120	30	9			
AEM90-LN1006-D32-W32-L150-Z04	●	32	4	32	150	50	9			

R: Sağ / Right / Rechts L: Sol/Left/Links

● Stokta / In Stock / Auf Lager ○ Stokta Yok / Non Stock Item / Kein Lagerartikel, Lieferzeit auf Anfrage
KRYL Ucuna Uygunur. / Compatible with KRYL Insert. Kompatibel mit KRYL Wendeplatten.

Sipariş Örneği/Ordering Example/Bestellbeispiel
1 ad./pcs./stück AEM90-BD11T3-D16-C16-L160-Z02-H



KAPR=90°

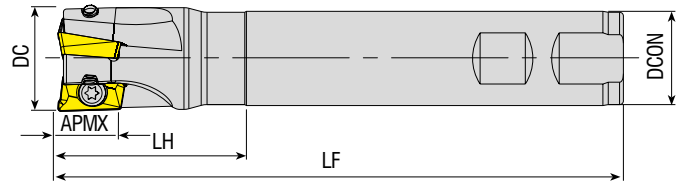

Takım Kodu Ordering Code Bestell-Bezeichnung	Stok Stock Lager	Takım Ölçüleri (mm) Dimension (mm) Abmessung (mm)						Kesici Uç Insert Wendeschneidplatte	Yedek Parçaları / Spare Parts / Ersatzteile	
		DC	ZEP	DCON	LF	LH	APMX		Sıkma Vidası Screw Schraube	Tork Anahtar Torx Key Torx-Schlüssel
AEM90-R390.11-D12-W12-L100-Z01	●	12	1	12	100	25	10			

SNDVK Ucuna Uygunur. / Compatible with SNDVK Insert. Kompatibel mit SNDVK Wendeplatten.



KAPR=90°

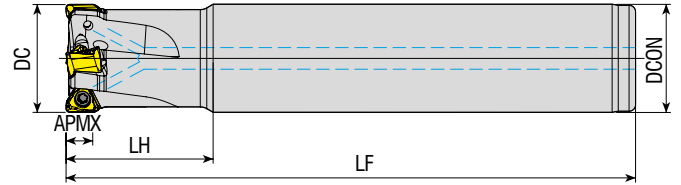

Takım Kodu Ordering Code Bestell-Bezeichnung	Stok Stock Lager	Takım Ölçüleri (mm) Dimension (mm) Abmessung (mm)						Kesici Uç Insert Wendeschneidplatte	Yedek Parçaları / Spare Parts / Ersatzteile	
		DC	ZEP	DCON	LF	LH	APMX		Sıkma Vidası Screw Schraube	Tork Anahtar Torx Key Torx-Schlüssel
AEM90-TNG10-D21-C20-L200-Z03-H	●	21	3	20	200	30	5			
AEM90-TNG10-D26-C25-L250-Z04-H	●	26	4	25	250	35	5			
AEM90-TNG10-D33-C32-L250-Z05-H	●	33	5	32	250	35	5			

R: Sağ / Right / Rechts L: Sol/Left/Links

● Stokta / In Stock / Auf Lager ○ Stokta Yok / Non Stock Item / Kein Lagerartikel, Lieferzeit auf Anfrage
PRMT Ucuna Uygunur. / Compatible with PRMT Insert. Kompatibel mit PRMT Wendeplatten.

Sipariş Örneği/Ordering Example/Bestellbeispiel
1 ad./pcs./stück AEM90-R390.11-D12-W12-L100-Z01



KAPR=90°

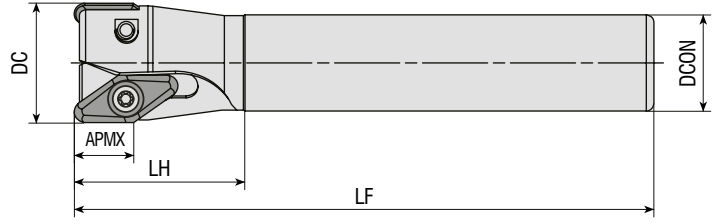

Takım Kodu Ordering Code Bestell-Bezeichnung	Stok Stock Lager	Takım Ölçüleri (mm) Dimension (mm) Abmessung (mm)						Kesici Uç Insert Wendeschneidplatte	Yedek Parçaları / Spare Parts / Ersatzteile	
		DC	ZEPF	DCON	LF	LH	APMX		Sıkma Vidası Screw Schraube	Tork Anahtar Torx Key Torx-Schlüssel
AEM90-VC2205-D32-C25-L150-Z02-H	●	32	2	25	150	50	15	VCKT 2205..	4015-M4.5x11	80-T15
AEM90-VC2205-D40-C32-L150-Z03-H	●	40	3	32	150	50	15			

ISO Ucuna Uygunur. / Compatiple with ISO Insert. Kompatibel mit ISO Wendeplatten.



KAPR=90°

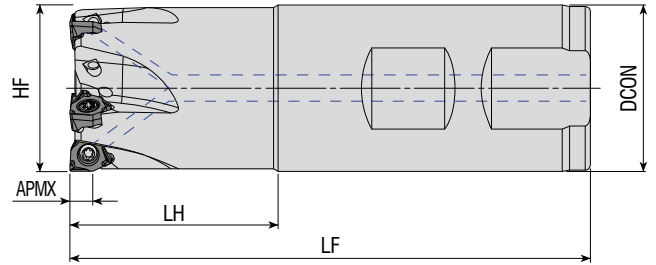

Takım Kodu Ordering Code Bestell-Bezeichnung	Stok Stock Lager	Takım Ölçüleri (mm) Dimension (mm) Abmessung (mm)						Kesici Uç Insert Wendeschneidplatte	Yedek Parçaları / Spare Parts / Ersatzteile	
		DC	ZEPF	DCON	LF	LH	APMX		Sıkma Vidası Screw Schraube	Tork Anahtar Torx Key Torx-Schlüssel
AEM90-WNG04-D20-W20-L81-Z03-H	●	20	3	20	81	31	4	WNGU 0403..	3008-M2.5x6	80-T08
AEM90-WNG04-D20-C20-L170-Z03-H	●	20	3	20	170	50	4			
AEM90-WNG04-D25-W25-L88-Z03-H	●	25	3	25	88	32	4			
AEM90-WNG04-D25-W25-L88-Z04-H	●	25	4	25	88	32	4			
AEM90-WNG04-D25-C25-L170-Z03-H	●	25	3	25	170	50	4			
AEM90-WNG04-D32-W25-L100-Z05-H	●	32	5	25	100	35	4			
AEM90-WNG04-D32-W32-L100-Z05-H	●	32	5	32	100	40	4			
AEM90-WNG04-D32-C25-L170-Z04-H	●	32	4	25	170	35	4			
AEM90-WNG04-D32-C32-L170-Z04-H	●	32	4	32	170	50	4			
AEM90-WNG08-D40-W32-L100-Z03-H	●	40	3	32	100	35	7.5			
AEM90-WNG08-D40-C32-L170-Z03-H	●	40	3	32	170	35	7.5			

R: Sağ / Right / Rechts L: Sol/Left/Links

● Stokta / In Stock / Auf Lager ○ Stokta Yok / Non Stock Item / Kein Lagerartikel, Lieferzeit auf Anfrage
XTC-GSC Ucuna Uygunur. / Compatiple with XTC-GSC Insert. Kompatibel mit XTC-GSC Wendeplatten.

Sipariş Örneği/Ordering Example/Bestellbeispiel

1 ad./pcs./stück AEM90-VC2205-D32-C25-L150-Z02-H



KAPR=90°

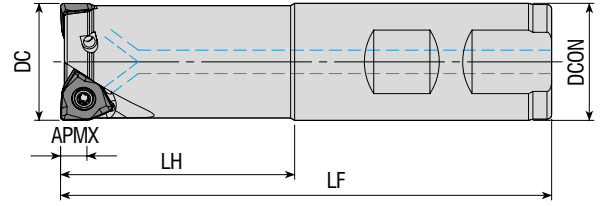

Takım Kodu Ordering Code Bestell-Bezeichnung	Stok Stock Lager	Takım Ölçüleri (mm) Dimension (mm) Abmessung (mm)						Kesici Uç Insert Wendeschneidplatte	Yedek Parçaları / Spare Parts / Ersatzteile	
		DC	ZEFP	DCON	LF	LH	APMX		Sıkma Vidası Screw Schraube	Tork Anahtar Torx Key Torx-Schlüssel
AEM90L-WN0604Z-D25-C25-L200-Z02-H	●	25	2	25	200	100	5.7			

ZCC Ucuna Uygundur. / Compatible with ZCC Insert. Kompatibel mit ZCC Wendeplatten.



KAPR=90°

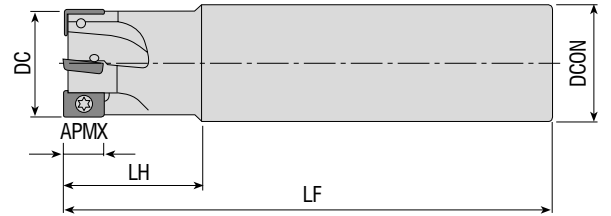

Takım Kodu Ordering Code Bestell-Bezeichnung	Stok Stock Lager	Takım Ölçüleri (mm) Dimension (mm) Abmessung (mm)						Kesici Uç Insert Wendeschneidplatte	Yedek Parçaları / Spare Parts / Ersatzteile	
		DC	ZEFP	DCON	LF	LH	APMX		Sıkma Vidası Screw Schraube	Tork Anahtar Torx Key Torx-Schlüssel
AEM90-ZC1003-D16-C16-L200-Z02	●	16	2	16	200	50	9			

R: Sağ / Right / Rechts L: Sol/Left/Links

● Stokta / In Stock / Auf Lager ○ Stokta Yok / Non Stock Item / Kein Lagerartikel, Lieferzeit auf Anfrage
DJT Ucuna Uygundur. / Compatible with DJT Insert. Kompatibel mit DJT Wendeplatten.

Sipariş Örneği/Ordering Example/Bestellbeispiel

1 ad./pcs./stück AEM90L-WN0604Z-D25-C25-L200-Z02-H



new

KAPR=90°

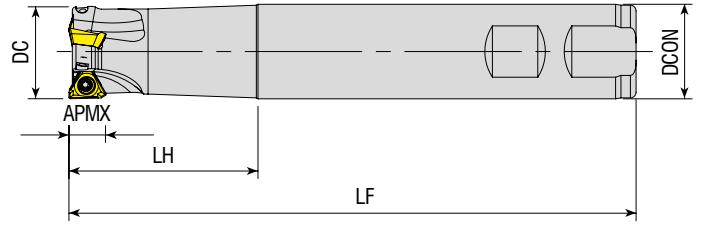

Takım Kodu Ordering Code Bestell-Bezeichnung	Stok Stock Lager	Takım Ölçüleri (mm) Dimension (mm) Abmessung (mm)						Kesici Uç Insert Wendeschneidplatte	Yedek Parçaları / Spare Parts / Ersatzteile			
		DC	ZEP	DCON	LF	LH	APMX		Sıkma Vidası Screw Schraube	Baskı Parçası Wedge Clamp Spannpratze	Baskı Vidası Clamp Screw Klemmschraube	Tork Anahtar Torx Key Torx-Schlüssel
AEM90-3P1505-D38-W32-L150-Z03	●	38	3	32	150	35	11				1115-M4x10	80-T15

TGTC Ucuna Uygun. / Compatible with TGTC Insert. Kompatibel mit TGTC Wendeplatten.

S-SİSTEM YÜZEY ve KOPYA PARMAK FREZELER
S-SYSTEM FACE and COPY END MILLS
S-SYSTEM KOPIER- UND SCHAFTFRÄSER

new

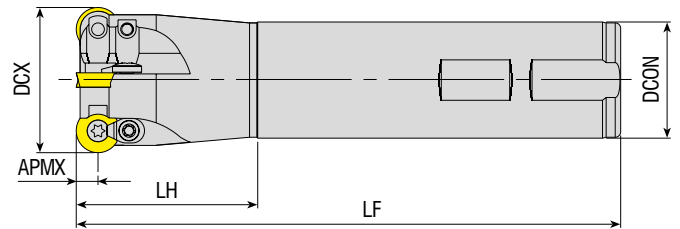

Takım Kodu Ordering Code Bestell-Bezeichnung	Stok Stock Lager	Takım Ölçüleri (mm) Dimension (mm) Abmessung (mm)						Kesici Uç Insert Wendeschneidplatte	Yedek Parçaları / Spare Parts / Ersatzteile							
		DCX	ZEP	DCON	LF	LH	APMX		Sıkma Vidası Screw Schraube	Baskı Parçası Wedge Clamp Spannpratze	Baskı Vidası Clamp Screw Klemmschraube	Tork Anahtar Torx Key Torx-Schlüssel				
AEMRC-RD10T3-D25-C25-L200-Z02-H	●	25	2	25	200	100	5						4015-M3.5x9	ACK-15	4015-M3.5x11	80-T15
AEMRC-RD10T3-D32-C25-L250-Z03-H	●															

R: Sağ / Right / Rechts L: Sol/Left/Links

● Stokta / In Stock / Auf Lager ○ Stokta Yok / Non Stock Item / Kein Lagerartikel, Lieferzeit auf Anfrage
ISO Ucuna Uygun. / Compatible with ISO Insert. Kompatibel mit ISO Wendeplatten.

Sipariş Örneği/Ordering Example/Bestellbeispiel
1 ad./pcs./stück AEM90-3P1505-D38-W32-L150-Z03

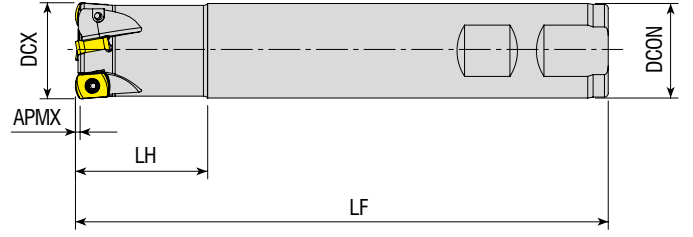

Takım Kodu Ordering Code Bestell-Bezeichnung	Stok Stock Lager	Takım Ölçüleri (mm) Dimension (mm) Abmessung (mm)						Kesici Uç Insert Wendeschneidplatte	Yedek Parçaları / Spare Parts / Ersatzteile	
		DCX	ZEP	DCON	LF	LH	APMX		Sıkma Vidası Screw Schraube	Tork Anahtar Torx Key Torx-Schlüssel
AHFM-BL0603-D33-C32-L150-Z05	●	33	5	32	150	40	1		3008-M2.5x6	80-T08

TGTC Ucuna Uygunur. / Compatiple with TGTC Insert. Kompatibel mit TGTC Wendeplatten.

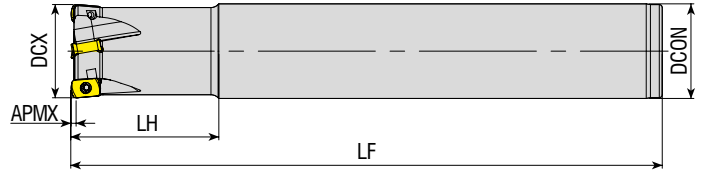

Takım Kodu Ordering Code Bestell-Bezeichnung	Stok Stock Lager	Takım Ölçüleri (mm) Dimension (mm) Abmessung (mm)						Kesici Uç Insert Wendeschneidplatte	Yedek Parçaları / Spare Parts / Ersatzteile	
		DCX	ZEP	DCON	LF	LH	APMX		Sıkma Vidası Screw Schraube	Tork Anahtar Torx Key Torx-Schlüssel
AHFM-EN1004-D16-C16-L250-Z02	●	16	2	16	250	70	1			
AHFM-EN1004-D20-C20-L250-Z03	●	20	3	20	250	70	1			
AHFM-EN1004-D21-C20-L150-Z03-H	●	21	3	20	150	30	1			
AHFM-EN1004-D33-C32-L200-Z04-H	●	33	4	32	200	30	1			

R: Sağ / Right / Rechts L: Sol/Left/Links

● Stokta / In Stock / Auf Lager ○ Stokta Yok / Non Stock Item / Kein Lagerartikel, Lieferzeit auf Anfrage
DJT Ucuna Uygunur. / Compatiple with DJT Insert. Kompatibel mit DJT Wendeplatten.

Sipariş Örneği/Ordering Example/Bestellbeispiel
1 ad./pcs./stück AHFM-BL0603-D33-C32-L150-Z05

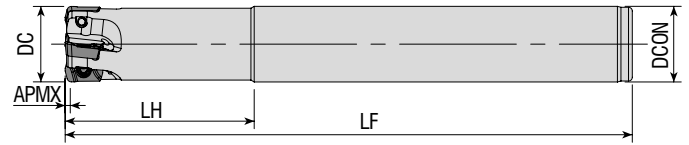

Takım Kodu Ordering Code Bestell-Bezeichnung	Stok Stock Lager	Takım Ölçüleri (mm) Dimension (mm) Abmessung (mm)						Kesici Uç Insert Wendeschneidplatte	Yedek Parçaları / Spare Parts / Ersatzteile	
		DC	ZEPF	DCON	LF	LH	APMX		Sıkma Vidası Screw Schraube	Tork Anahtar Torx Key Torx-Schlüssel
AHFM-EP1003-D25-C25-L200-Z04-H	●	25	4	25	200	100	1			
AHFM-EP1003-D25-C25-L250-Z04-H	●	25	4	25	250	100	1			

DJT Ucuna Uygunur. / Compatiple with DJT Insert. Kompatibel mit DJT Wendepatten.

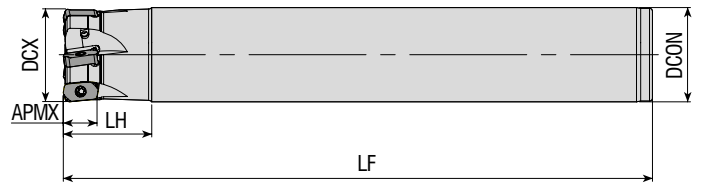

Takım Kodu Ordering Code Bestell-Bezeichnung	Stok Stock Lager	Takım Ölçüleri (mm) Dimension (mm) Abmessung (mm)						Kesici Uç Insert Wendeschneidplatte	Yedek Parçaları / Spare Parts / Ersatzteile	
		DCX	ZEPF	DCON	LF	LH	APMX		Sıkma Vidası Screw Schraube	Tork Anahtar Torx Key Torx-Schlüssel
AHFM-LN0303-D16-C15-L150-Z02	●	16	2	15	150	30	12			
AHFM-LN0303-D16-W16-L150-Z02-H	●	16	2	16	150	50	12			
AHFM-LN0303-D20-W20-L150-Z03-H	●	20	3	20	150	50	12			
AHFM-LN0303-D21-C20-L150-Z03	●	21	3	20	150	30	12			
AHFM-LN0303-D25-W25-L150-Z04-H	●	25	4	25	150	50	12			
AHFM-LN0303-D26-C25-L150-Z04	●	26	4	25	150	30	12			
AHFM-LN0303-D33-C32-L200-Z05	●	33	5	32	200	30	12			

R: Sağ / Right / Rechts L: Sol/Left/Links

● Stokta / In Stock / Auf Lager ○ Stokta Yok / Non Stock Item / Kein Lagerartikel, Lieferzeit auf Anfrage

TNGYL Ucuna Uygunur. / Compatiple with TNGYL Insert. Kompatibel mit TNGYL Wendepatten.

Sipariş Örneği/Ordering Example/Bestellbeispiel
1 ad./pcs./stück AHFM-EP1003-D25-C25-L200-Z04-H

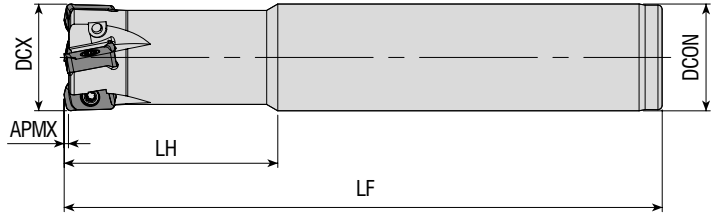

Takım Kodu Ordering Code Bestell-Bezeichnung	Stok Stock Lager	Takım Ölçüleri (mm) Dimension (mm) Abmessung (mm)						Kesici Uç Insert Wendeschneidplatte	Yedek Parçaları / Spare Parts / Ersatzteile	
		DCX	ZEPF	DCON	LF	LH	APMX		Sıkma Vidası Screw Schraube	Tork Anahtar Torx Key Torx-Schlüssel
AHFM-L003-D21-C20-L150-Z03-H	●	21	3	20	150	30	1	LOGU 0303..	1108-M3x6.8	80-T08
AHFM-L003-D21-C20-L200-Z03-H	●	21	3	20	200	30	1			

KYCR Ucuna Uygunur. / Compatible with KYCR Insert. Kompatibel mit KYCR Wendeplatten.
F: Eksenel ve Radyal Salgı Değeri 0,02 mm içindedir. / F: Axial and Radial Runout Value is within 0,02 mm.
F: Der axiale und radiale Rundlaufwert liegt innerhalb von 0,02 mm.

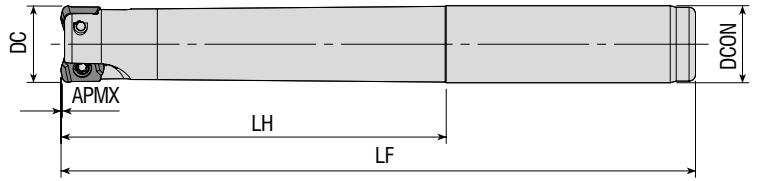

Takım Kodu Ordering Code Bestell-Bezeichnung	Stok Stock Lager	Takım Ölçüleri (mm) Dimension (mm) Abmessung (mm)						Kesici Uç Insert Wendeschneidplatte	Yedek Parçaları / Spare Parts / Ersatzteile	
		DC	ZEPF	DCON	LF	LH	APMX		Sıkma Vidası Screw Schraube	Tork Anahtar Torx Key Torx-Schlüssel
AHFM-Y00602-D12-C12-L120-Z02-H	●	12	2	12	120	60	0.3	YOHW 0602..	3006-M1.8X4	80-T06
AHFM-Y00602-D12-C12-L120-Z03-H	●	12	3	12	120	60	0.3			

R: Sağ / Right / Rechts L: Sol/Left/Links

● Stokta / In Stock / Auf Lager ○ Stokta Yok / Non Stock Item / Kein Lagerartikel, Lieferzeit auf Anfrage
DJT Ucuna Uygunur. / Compatible with DJT Insert. Kompatibel mit DJT Wendeplatten.



F: Eksenel ve Radyal Salgı Değeri 0,02 mm içindedir. / F: Axial and radial runout value is within 0,02mm / F: Der axiale und radiale Rundlaufwert liegt innerhalb von 0,02 mm.

Sipariş Örneği/Ordering Example/Bestellbeispiel
1 ad./pcs./stück AHFM-L003-D21-C20-L150-Z03-H

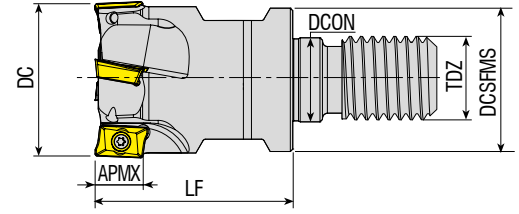

KAPR=90°





Takım Kodu Ordering Code Bestell-Bezeichnung	Stok Stock Lager	Takım Ölçüleri (mm) Dimension (mm) Abmessung (mm)							Kesici Uç Insert Wendeschneidplatte	Yedek Parçaları / Spare Parts / Ersatzteile	
		DC	ZEFP	DCSFMS	TDZ	LF	DCON	APMX		Sıkma Vidası Screw Schraube	Tork Anahtar Torx Key Torx-Schlüssel
AEM90-AP0903-D20-M12-L35-Z03	●	20	3	18	M12	35	12.5	9	 APMT 0903.. KRILY UCUNA UYGUNDUR. FOR KRILY INSERT. Kompatibel mit Wendeschneidplatte KRILY	 3008-M2.5x6	 80-T08
AEM90-AP0903-D25-M12-L35-Z03	●	25	3	21	M12	35	12.5	9			
AEM90-AP10-D32-M16-L40-Z04-H	●	32	4	29	M16	40	17	10			

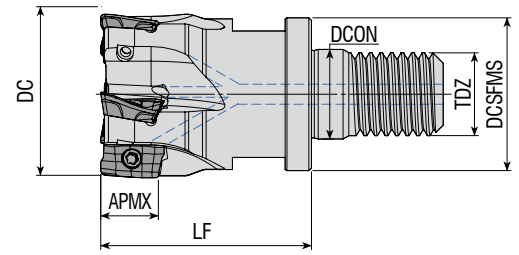

KAPR=90°

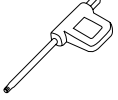

Takım Kodu Ordering Code Bestell-Bezeichnung	Stok Stock Lager	Takım Ölçüleri (mm) Dimension (mm) Abmessung (mm)							Kesici Uç Insert Wendeschneidplatte	Yedek Parçaları / Spare Parts / Ersatzteile	
		DC	ZEFP	DCSFMS	TDZ	LF	DCON	APMX		Sıkma Vidası Screw Schraube	Tork Anahtar Torx Key Torx-Schlüssel
AEM90-BD11T3-D16-M08-L25-Z02-H	●	16	2	14.75	M08	25	8.5	10	 BDMT 11T3..	 3008-M2.5x6	 80-T08
AEM90-BD11T3-D25-M12-L35-Z04-H	●	25	4	21	M12	35	12.5	10			
AEM90-BD11T3-D32-M16-L40-Z05-H	●	32	5	29	M16	40	17	10			



R: Sağ / Right / Rechts L: Sol/Left/Links
● Stokta / In Stock / Auf Lager ○ Stokta Yok / Non Stock Item / Kein Lagerartikel, Lieferzeit auf Anfrage
KYCR Ucuna Uygun. / Compatiple with KYCR Insert. Kompatibel mit KYCR Wendeplatten.

Sipariş Örneği/Ordering Example/Bestellbeispiel
1 ad./pcs./stück AHFM-EP1003-D25-C25-L200-Z04-H

new

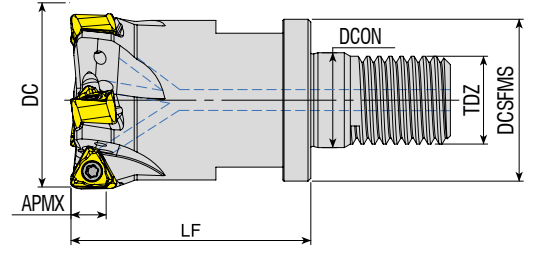
KAPR=90°





Takım Kodu Ordering Code Bestell-Bezeichnung	Stok Stock Lager	Takım Ölçüleri (mm) Dimension (mm) Abmessung (mm)							Kesici Uç Insert Wendeschneidplatte	Yedek Parçaları / Spare Parts / Ersatzteile	
		DC	ZEFP	DCSFMS	TDZ	LF	DCON	APMX		Sıkma Vidası Screw Schraube	Tork Anahtar Torx Key Torx-Schlüssel
AEM90-TNG10-D21-M10-L25-Z03-H	●	21	3	18	M10	25	10.5	5			
AEM90-TNG10-D26-M12-L30-Z04-H	●	26	4	21	M12	30	12.5	5			
AEM90-TNG10-D33-M16-L43-Z05-H	●	33	5	29	M16	43	17	5			
AEM90-TNG10-D35-M16-L43-Z05-H	●	35	5	29	M16	43	17	5			

PRMT Ucuna Uygunur. / Compatible with PRMT Insert. Kompatibel mit PRMT Wendeplatten.

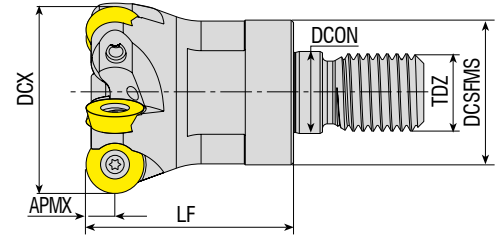
new



Takım Kodu Ordering Code Bestell-Bezeichnung	Stok Stock Lager	Takım Ölçüleri (mm) Dimension (mm) Abmessung (mm)							Kesici Uç Insert Wendeschneidplatte	Yedek Parçaları / Spare Parts / Ersatzteile	
		DCX	ZEFP	DCSFMS	TDZ	LF	DCON	APMX		Sıkma Vidası Screw Schraube	Tork Anahtar Torx Key Torx-Schlüssel
AEMR-RD10T3-D25-M12-L35-Z03-H	●	25	3	21	M12	35	12.5	5			
AEMR-RD10T3-D32-M16-L45-Z04-H	●	32	4	29	M16	45	17	5			

R: Sağ / Right / Rechts L: Sol/Left/Links

● Stokta / In Stock / Auf Lager ○ Stokta Yok / Non Stock Item / Kein Lagerartikel, Lieferzeit auf Anfrage
 ISO Ucuna Uygunur. / Compatible with ISO Insert. Kompatibel mit ISO Wendeplatten.

Sipariş Örneği/Ordering Example/Bestellbeispiel
 1 ad./pcs./stück AEM90-TNG10-D21-M10-L25-Z03-H

new

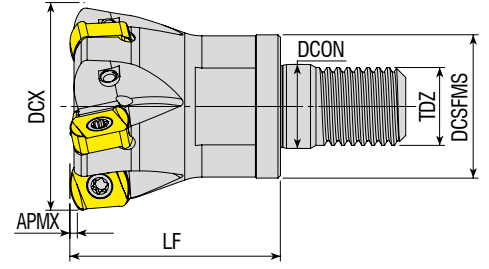

Takım Kodu Ordering Code Bestell-Bezeichnung	Stok Stock Lager	Takım Ölçüleri (mm) Dimension (mm) Abmessung (mm)							Kesici Uç Insert Wendeschneidplatte	Yedek Parçaları / Spare Parts / Ersatzteile		
		DCX	ZEPF	DCSFMS	TDZ	LF	DCON	APMX		Sıkma Vidası Screw Schraube	Tork Anahtar Torx Key Torx-Schlüssel	
AHFM-BL0904-D32-M16-L43-Z04-H		32	4	29	M16	43	17	1.5				
									BLMP 0904..	3010-M3.5x9	80-T10	

TGTC Ucuna Uygunur. / Compatible with TGTC Insert. Kompatibel mit TGTC Wendeplatten.

new

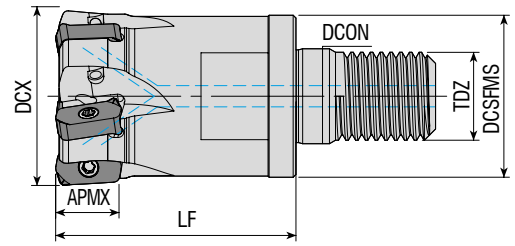

Takım Kodu Ordering Code Bestell-Bezeichnung	Stok Stock Lager	Takım Ölçüleri (mm) Dimension (mm) Abmessung (mm)							Kesici Uç Insert Wendeschneidplatte	Yedek Parçaları / Spare Parts / Ersatzteile				
		DCX	ZEPF	DCSFMS	TDZ	LF	DCON	APMX		Sıkma Vidası Screw Schraube	Baskı Parçası Wedge Clamp Spannpratze	Baskı Vidası Clamp Screw Klemmschraube	Tork Anahtar Torx Key Torx-Schlüssel	
AHFM-LN0303-D25-M12-L35-Z04-H	●	25	4	21	M12	35	12.5	12						
AHFM-LN0303-D32-M16-L43-Z05-H	●	32	5	29	M16	43	17	12	LNMU 0303..	3008-M2.5x6	-	-	80-T08	
AHFM-LN0303-D42-M16-L43-Z06-H	●	42	6	29	M16	43	17	12						

R: Sağ / Right / Rechts L: Sol/Left/Links

● Stokta / In Stock / Auf Lager ○ Stokta Yok / Non Stock Item / Kein Lagerartikel, Lieferzeit auf Anfrage

TNGYL Ucuna Uygunur. / Compatible with TNGYL Insert. Kompatibel mit TNGYL Wendeplatten.

Sipariş Örneği/Ordering Example/Bestellbeispiel
1 ad./pcs./stück AHFM-BL0904-D32-M16-L43-Z04-H

S-SİSTEM HIZLI İLERLEMELİ MODÜLER PARMAK FREZELER
S-SYSTEM MODULAR (SCREW TYPE) HIGHFEED END MILLS
S-SYSTEM HOCHVORSCHUB-EINSCHRAUBFRÄSER

new

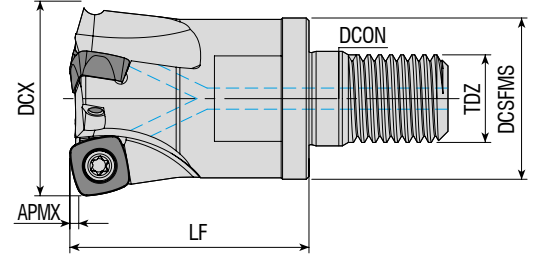

Takım Kodu Ordering Code Bestell-Bezeichnung	Stok Stock Lager	Takım Ölçüleri (mm) Dimension (mm) Abmessung (mm)							Kesici Uç Insert Wendeschneidplatte	Yedek Parçaları / Spare Parts / Ersatzteile			
		DCX	ZEPF	DCSFMS	TDZ	LF	DCON	APMX		Sıkma Vidası Screw Schraube	Baskı Parçası Wedge Clamp Spannpratze	Baskı Vidası Clamp Screw Klemmschraube	Tork Anahtar Torx Key Torx-Schlüssel
AHFM-SP1004-D25-M12-L35-Z02-H	●	25	2	21	M12	35	12.5	1			-	-	
	●												
	●												
	●												

DJT Ucuna Uygundur. / Compatible with DJT Insert. Kompatibel mit DJT Wendepfatten.

KÜRE UÇLU PARMAK FREZELER
BALL NOSE END MILLS
KUGELKOPIERFRÄSER

new

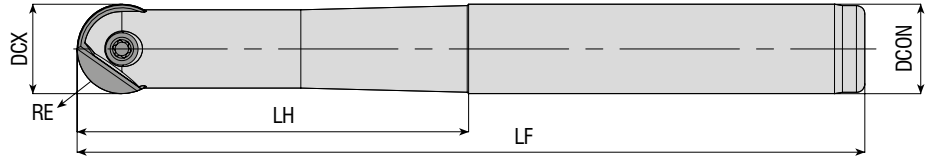

Takım Kodu Ordering Code Bestell-Bezeichnung	Stok Stock Lager	Takım Ölçüleri (mm) Dimension (mm) Abmessung (mm)					Kesici Uç Insert Wendeschneidplatte	Yedek Parçaları / Spare Parts / Ersatzteile	
		DCX	RE	DCON	LF	LH		Sıkma Vidası Screw Schraube	Tork Anahtar Torx Key Torx-Schlüssel
APMR-BNM16-D16-C16-L200	●	16	8	16	200	100			
APMR-BNM20-D20-C20-L160	●	20	10	20	160	70			
APMR-BNM20-D20-C20-L200	●	20	10	20	200	100			
APMR-BNM20-D20-C20-L250	●	20	10	20	250	150			
APMR-BNM25-D25-C25-L160	●	25	12.5	25	160	70			
APMR-BNM25-D25-C25-L200	●	25	12.5	25	200	100			
APMR-BNM25-D25-C25-L250	●	25	12.5	25	250	150			

R: Sağ / Right / Rechts L: Sol/Left/Links

● Stokta / In Stock / Auf Lager ○ Stokta Yok / Non Stock Item / Kein Lagerartikel, Lieferzeit auf Anfrage
 DJT Ucuna Uygundur. / Compatible with DJT Insert. Kompatibel mit DJT Wendepfatten.

Sipariş Örneği/Ordering Example/Bestellbeispiel
 1 ad./pcs./stück AHFM-SP1004-D25-M12-L35-Z02-H

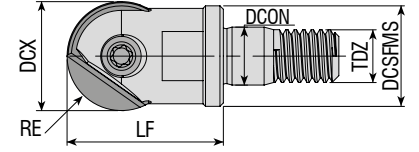

Takım Kodu Ordering Code Bestell-Bezeichnung	Stok Stock Lager	Takım Ölçüleri (mm) Dimension (mm) Abmessung (mm)						Kesici Uç Insert Wendeschneidplatte	Yedek Parçaları / Spare Parts / Ersatzteile		
		DCX	RE	DCSFMS	TDZ	LF	DCON		Sıkma Vidası Screw Schraube	Tork Anahtar Torx Key Torx-Schlüssel	
APMR-BNM12-D12-M06-L20	●	12	6	11	M06	20	6.5				
APMR-BNM16-D16-M08-L23	●	16	8	14.75	M08	23	8.5				
APMR-BNM20-D20-M10-L30	●	20	10	18	M10	30	10.5				

DJT Ucuna Uygundur. / Compatiple with DJT Insert. Kompatibel mit DJT Wendeplatten.

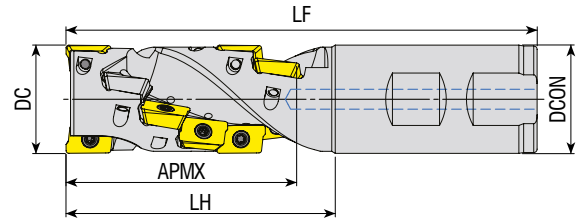

Takım Kodu Ordering Code Bestell-Bezeichnung	Stok Stock Lager	Takım Ölçüleri (mm) Dimension (mm) Abmessung (mm)						Kesici Uç Insert Wendeschneidplatte	Yedek Parçaları / Spare Parts / Ersatzteile		
		ZEFP		DC	DCON	APMX	LH		LF	Sıkma Vidası Screw Schraube	Tork Anahtar Torx Key Torx-Schlüssel
		Toplam Total Gesamt	Etkili Effective Effektiv								
AHM90-AP1204-D32-W32-L140-Z0212-H	●	12	2	32	32	68	80	140			
AHM90-AP1204-D40-W32-L160-Z0321-H	●	21	3	40	32	79	100	160			

R: Sağ / Right / Rechts L: Sol/Left/Links

● Stokta / In Stock / Auf Lager ○ Stokta Yok / Non Stock Item / Kein Lagerartikel, Lieferzeit auf Anfrage
TGTC Ucuna Uygundur. / Compatiple with TGTC Insert. Kompatibel mit TGTC Wendeplatten.

Sipariş Örneği/Ordering Example/Bestellbeispiel
1 ad./pcs./stück APMR-BNM12-D12-M06-L20



KAPR=45°

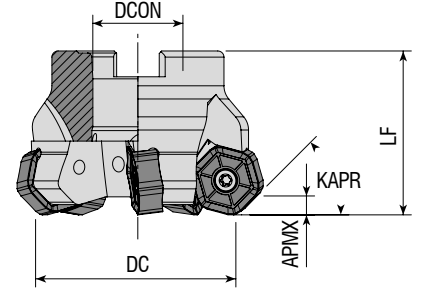

Takım Kodu Ordering Code Bestell-Bezeichnung	Stok Stock Lager	Takım Ölçüleri (mm) Dimension (mm) Abmessung (mm)					Kesici Uç Insert Wendeschneidplatte	Yedek Parçaları / Spare Parts / Ersatzteile		
		DC	ZEFP	DCON	LF	APMX		Sıkma Vidası Screw Schraube	Tork Anahtar Torx Key Torx-Schlüssel	Montaj Vidası Mounting Screw Befestigungsschraube
AFM45L-HN0905-D100-A32-Z08-H	●	100	8	32	50	4.5	HN.. 0905..	4015-M4x11	80-T15	2514-M16x35
AFM45L-HN0905-D125-B40-Z10	●	125	10	40	63	4.5				-

WDA Ucuna Uygun. / Compatible with WDA Insert. Kompatibel mit WDA Wendeplatten.



KAPR=45°

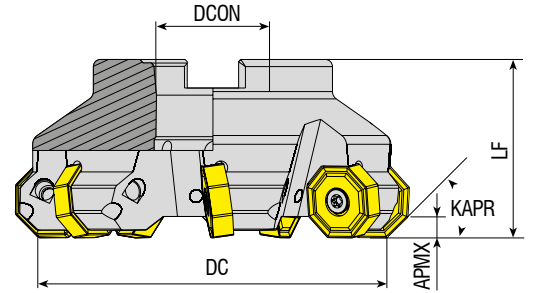

Takım Kodu Ordering Code Bestell-Bezeichnung	Stok Stock Lager	Takım Ölçüleri (mm) Dimension (mm) Abmessung (mm)					Kesici Uç Insert Wendeschneidplatte	Yedek Parçaları / Spare Parts / Ersatzteile		
		DC	ZEFP	DCON	LF	APMX		Sıkma Vidası Screw Schraube	Tork Anahtar Torx Key Torx-Schlüssel	Montaj Vidası Mounting Screw Befestigungsschraube
AFM45-ON0806-D100-A32-Z10	●	100	10	32	50	5.5	ON.. 0806..	1020-M5x14	80-T20	2514-M16x35
AFM45-ON0806-D125-B40-Z12	●	125	12	40	63	5.5				-
AFM45-ON0806-D160-C40-Z14	●	160	14	40	63	5.5				-
AFM45-ON0806-D250-C60-Z14	●	250	14	60	63	5.5				-

R: Sağ / Right / Rechts L: Sol/Left/Links





● Stokta / In Stock / Auf Lager ○ Stokta Yok / Non Stock Item / Kein Lagerartikel, Lieferzeit auf Anfrage
ISO Ucuna Uygun. / Compatible with ISO Insert. Kompatibel mit ISO Wendeplatten.

Sipariş Örneği/Ordering Example/Bestellbeispiel
1 ad./pcs./stück AFM45L-HN0905-D100-A32-Z08-H

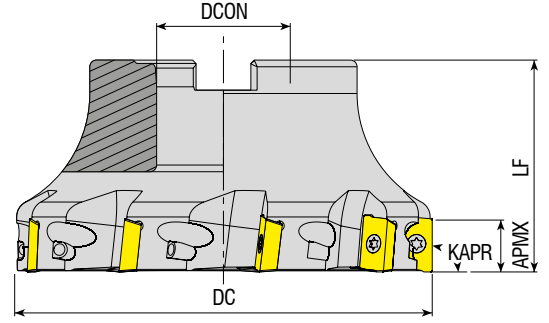
new

KAPR=90°







Takım Kodu Ordering Code Bestell-Bezeichnung	Stok Stock Lager	Takım Ölçüleri (mm) Dimension (mm) Abmessung (mm)					Kesici Uç Insert Wendeschneidplatte	Yedek Parçaları / Spare Parts / Ersatzteile		
		DC	ZEFP	DCON	LF	APMX		Sıkma Vidası Screw Schraube	Tork Anahtar Torx Key Torx-Schlüssel	Montaj Vidası Mounting Screw Befestigungsschraube
AFM90-AP16Y-D063-A22-Z06-H	●	63	6	22	40	16				
							AP. 1604..	4015-M4x11	80-T15	2508-M10x30

YG Ucuna Uygun. / Compatible with YG Insert. Kompatibel mit YG Wendeplatten.

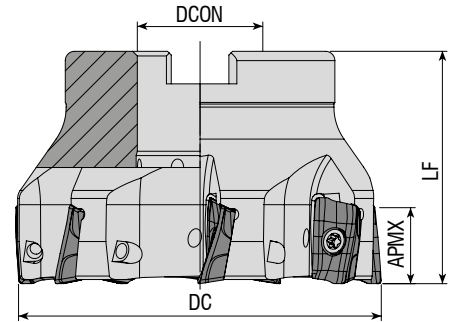
new

KAPR=90°



Takım Kodu Ordering Code Bestell-Bezeichnung	Stok Stock Lager	Takım Ölçüleri (mm) Dimension (mm) Abmessung (mm)					Kesici Uç Insert Wendeschneidplatte	Yedek Parçaları / Spare Parts / Ersatzteile					
		DC	ZEFP	DCON	LF	APMX		Sıkma Vidası Screw Schraube	Tork Anahtar Torx Key Torx-Schlüssel	Montaj Vidası Mounting Screw Befestigungsschraube			
AFM90-BD11T3-D040-A16-Z05-H	●	40	5	16	40	10							
AFM90-BD1704-D050-A22-Z04-H	●	50	4	22	40	15.7	BDMT 11T3..	3008-M2.5x6	80-T08	2506-M8x30			
AFM90-BD1704-D080-A27-Z06-H	●	80	6	27	50	15.7				BDMT 1704..	4015-M4x11	80-T15	2508-M10x30
AFM90-BD1704-D100-A32-Z07-H	●	100	7	32	50	15.7							2510-M12x35
													2514-M16x35

R: Sağ / Right / Rechts L: Sol/Left/Links

● Stokta / In Stock / Auf Lager ○ Stokta Yok / Non Stock Item / Kein Lagerartikel, Lieferzeit auf Anfrage
KYCR Ucuna Uygun. / Compatible with KYCR Insert. Kompatibel mit KYCR Wendeplatten.

Sipariş Örneği/Ordering Example/Bestellbeispiel
1 ad./pcs./stück AFM90-AP16Y-D063-A22-Z06-H



KAPR=90°

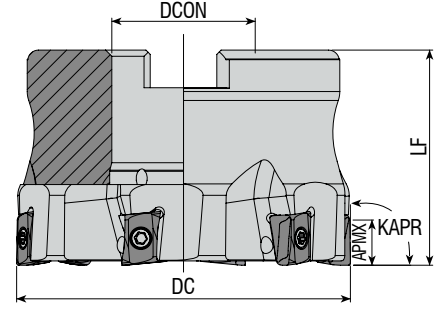

Takım Kodu Ordering Code Bestell-Bezeichnung	Stok Stock Lager	Takım Ölçüleri (mm) Dimension (mm) Abmessung (mm)					Kesici Uç Insert Wendeschneidplatte	Yedek Parçaları / Spare Parts / Ersatzteile		
		DC	ZEFP	DCON	LF	APMX		Sıkma Vidası Screw Schraube	Tork Anahtar Torx Key Torx-Schlüssel	Montaj Vidası Mounting Screw Befestigungsschraube
AFM90-L008-D040-A16-Z06-H	●	40	6	16	40	2	LOEX 0804..	3008-M2.5x8	80-T08	2506-M8x30
AFM90-L008-D050-A22-Z07-H	●	50	7	22	40	2				2508-M10x30
AFM90-L008-D063-A27-Z06-H	●	63	6	27	40	2				2510-M12x35

SC Ucuna Uygundur. / Compatible with SC Insert. Kompatibel mit SC Wendeplatten.



KAPR=90°

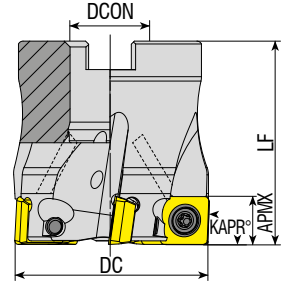

Takım Kodu Ordering Code Bestell-Bezeichnung	Stok Stock Lager	Takım Ölçüleri (mm) Dimension (mm) Abmessung (mm)					Kesici Uç Insert Wendeschneidplatte	Yedek Parçaları / Spare Parts / Ersatzteile		
		DC	ZEFP	DCON	LF	APMX		Sıkma Vidası Screw Schraube	Tork Anahtar Torx Key Torx-Schlüssel	Montaj Vidası Mounting Screw Befestigungsschraube
AFM90-SP09T3-D040-A16-Z05-H	●	40	5	16	40	8.6	SPMT 09T3..	3010-M3.5x9	80-T10	2506-M8x30
AFM90-SP09T3-D050-A22-Z06-H	●	50	6	22	40	8.6				2508-M10x30
AFM90-SP09T3-D063-A22-Z07-H	●	63	7	22	40	8.6				2510-M12x35
AFM90-SP09T3-D080-A27-Z08-H	●	80	8	27	50	8.6				

R: Sağ / Right / Rechts L: Sol/Left/Links

● Stokta / In Stock / Auf Lager ○ Stokta Yok / Non Stock Item / Kein Lagerartikel, Lieferzeit auf Anfrage

SNDVK Ucuna Uygundur. / Compatible with SNDVK Insert. Kompatibel mit SNDVK Wendeplatten.

Sipariş Örneği/Ordering Example/Bestellbeispiel
1 ad./pcs./stück AFM90-L008-D040-A16-Z06-H

new

KAPR=90°

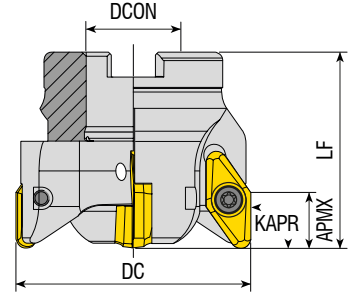

Takım Kodu Ordering Code Bestell-Bezeichnung	Stok Stock Lager	Takım Ölçüleri (mm) Dimension (mm) Abmessung (mm)					Kesici Uç Insert Wendeschneidplatte	Yedek Parçaları / Spare Parts / Ersatzteile		
		DC	ZEFP	DCON	LF	APMX		Sıkma Vidası Screw Schraube	Tork Anahtar Torx Key Torx-Schlüssel	Montaj Vidası Mounting Screw Befestigungsschraube
AFM90-VC2205-D050-A22-Z03-H	●	50	3	22	55	15	VCKT 2205..	4015-M4.5x11	80-T15	2508-M10x30
AFM90-VC2205-D063-A22-Z04-H	●	63	4	22	55	15				
AFM90-VC2205-D066-A27-Z04-H	●	66	4	27	55	15				
AFM90-VC2205-D080-A27-Z05-H	●	80	5	27	60	15				2510-M12x35

ISO Ucuna Uygun. / Compatible with ISO Insert. Kompatibel mit ISO Wendeplatten.

new

KAPR=90°

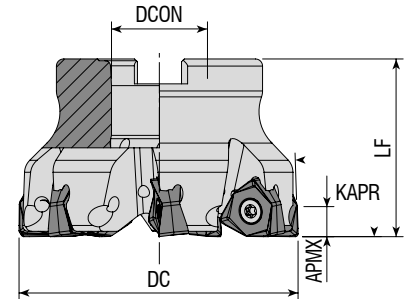

Takım Kodu Ordering Code Bestell-Bezeichnung	Stok Stock Lager	Takım Ölçüleri (mm) Dimension (mm) Abmessung (mm)					Kesici Uç Insert Wendeschneidplatte	Yedek Parçaları / Spare Parts / Ersatzteile		
		DC	ZEFP	DCON	LF	APMX		Sıkma Vidası Screw Schraube	Tork Anahtar Torx Key Torx-Schlüssel	Montaj Vidası Mounting Screw Befestigungsschraube
AFM90-WNG04-D040-A16-Z06-H	●	40	6	16	40	4	WNGU 0403..	3008-M2.5x6	80-T08	2506-M8x30
AFM90-WNG04-D050-A22-Z05-H	●	50	5	22	40	4				
AFM90-WNG04-D050-A22-Z07-H	●	50	7	22	40	4				
AFM90-WNG04-D063-A22-Z06-H	●	63	6	22	40	4				2508-M10x30
AFM90-WNG08-D050-A22-Z05-H	●	50	5	22	40	7.5	WNGU 0806..	4015-M4x11	80-T15	2510-M12x35
AFM90-WNG08-D063-A22-Z06-H	●	63	6	22	40	7.5				
AFM90-WNG08-D080-A27-Z07-H	●	80	7	27	50	7.5				

R: Sağ / Right / Rechts L: Sol/Left/Links

● Stokta / In Stock / Auf Lager ○ Stokta Yok / Non Stock Item / Kein Lagerartikel, Lieferzeit auf Anfrage
XTC-GSC Ucuna Uygun. / Compatible with XTC-GSC Insert. Kompatibel mit XTC-GSC Wendeplatten.

Sipariş Örneği/Ordering Example/Bestellbeispiel
1 ad./pcs./stück AFM90-VC2205-D050-A22-Z03-H



KAPR=90°

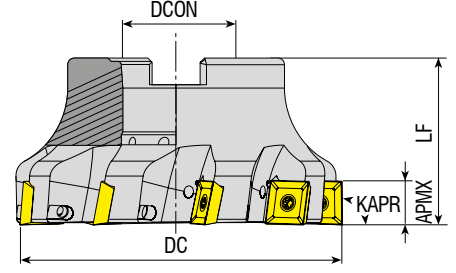

Takım Kodu Ordering Code Bestell-Bezeichnung	Stok Stock Lager	Takım Ölçüleri (mm) Dimension (mm) Abmessung (mm)					Kesici Uç Insert Wendeschneidplatte	Yedek Parçaları / Spare Parts / Ersatzteile			
		DC	ZEFP	DCON	LF	APMX		Sıkma Vidası Screw Schraube	Tork Anahtar Torx Key Torx-Schlüssel	Montaj Vidası Mounting Screw Befestigungsschraube	
AFM90-490R08-D063-A22-Z06-H	●	63	6	22	40	5.5	490R-08T3..	3008-M2.5x6	80-T08	2508-M10x30	
AFM90-490R14-D100-A32-Z07-H	●	100	7	32	50	10				2514-M16x35	
AFM90-490R14-D125-B40-Z08	●	125	8	40	63	10	490R-1404..	4015-M3.5x9	80-T15	-	
AFM90-490R14-D160-C40-Z12	●	160	12	40	63	10					
AFM90-490R14-D200-C60-Z16	●	250	16	60	63	10					

SNDVK Ucuna Uygunur. / Compatible with SNDVK Insert. Kompatibel mit SNDVK Wendeplatten.

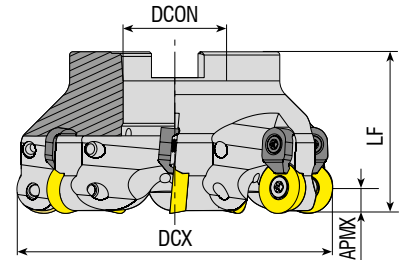

Takım Kodu Ordering Code Bestell-Bezeichnung	Stok Stock Lager	Takım Ölçüleri (mm) Dimension (mm) Abmessung (mm)					Kesici Uç Insert Wendeschneidplatte	Yedek Parçaları / Spare Parts / Ersatzteile				
		DCX	ZEFP	DCON	LF	APMX		Sıkma Vidası Screw Schraube	Baskı Parçası Wedge Clamp Spannpratze	Baskı Vidası Clamp Screw Klemmschraube	Tork Anahtar Torx Key Torx-Schlüssel	Montaj Vidası Mounting Screw Befestigungsschraube
AFMRC-RD1604-D160-C40-Z08	●	160	8	40	63	8	RD.. 1604..	34015-M4.5x11	ACK-05	4015-M4x11	80-T15	-

R: Sağ / Right / Rechts L: Sol/Left/Links

● Stokta / In Stock / Auf Lager ○ Stokta Yok / Non Stock Item / Kein Lagerartikel, Lieferzeit auf Anfrage
ISO Ucuna Uygunur. / Compatible with ISO Insert. Kompatibel mit ISO Wendeplatten.

Sipariş Örneği/Ordering Example/Bestellbeispiel
1 ad./pcs./stück AFM90-490R08-D063-A22-Z06-H

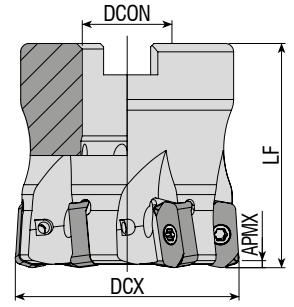

Takım Kodu Ordering Code Bestell-Bezeichnung	Stok Stock Lager	Takım Ölçüleri (mm) Dimension (mm) Abmessung (mm)					Kesici Uç Insert Wendeschneidplatte	Yedek Parçaları / Spare Parts / Ersatzteile		
		DCX	ZEFP	DCON	LF	APMX		Sıkma Vidası Screw Schraube	Tork Anahtar Torx Key Torx-Schlüssel	Montaj Vidası Mounting Screw Befestigungsschraube
AHFM-LN0303-D040-A16-Z06-H	●	40	6	16	40	12	LNMU 0303..	3008-M2.5X6	80-T08	2506-M8x30
AHFM-LN0303-D050-A22-Z07-H	●	50	7	22	50	12				2508-M10x30
AHFM-LN0303-D063-A22-Z09-H	●	63	9	22	50	12				

R: Sağ / Right / Rechts L: Sol/Left/Links

● Stokta / In Stock / Auf Lager ○ Stokta Yok / Non Stock Item / Kein Lagerartikel, Lieferzeit auf Anfrage
TNGYL Ucuna Uygunudur. / Compatible with TNGYL Insert. Kompatibel mit TNGYL Wendeplatten.

Sipariş Örneği/Ordering Example/Bestellbeispiel
1 ad./pcs./stück AHFM-LN0303-D040-A16-Z06-H



Konya Organize Sanayi Bölgesi
İşiktepe Sk. No:6 P.K. 42250
Selçuklu / KONYA / TÜRKİYE

Tel : +90 332 239 17 57 (pbx)
Fax : +90 332 239 17 52
GPS: 37,973262 N / 32,604158 E

www.akko.com.tr
akko@akko.com.tr
export@akko.com.tr



Yenilikler için bizi takip edin!
Follow us for news!
Für Neuheiten bitte uns folgen